



Atlas Copco



Complete submersible dewatering solutions

The technical drawing overlay shows a cross-section of a pump or motor with various dimensions and labels, including '1380 (1442)', '1634 (1698)', '1780 (1846)', and 'C-C (1:3)'.

The WEDA range (50 Hz)

WEDA dewatering pumps

WEDA electric submersible pumps and accessories are designed for an extensive range of dewatering applications, across multiple industries. They provide the performance, reliability and ease of use you need. WEDA pumps feature a built-in starter and motor protection system along with optional automatic level control. Adjustable wear-resistant rubber diffusers and hardened high-chrome impellers ensure durability in tough environments.

At Atlas Copco, we understand pumps, their applications and, most importantly, the people using them. We have a complete range of high-quality and lightweight electric submersible pumps designed specifically for drainage, sludge and slurry pumping applications and available in global voltages.















WEDA pumps are made for durability. The unique sealing system and modular design make them among the most flexible pumps on the market. Easy to use and maintain, WEDA pumps promise optimal performance. The WEDA seal system is designed to provide the optimum maintenance solution and can be easily fitted at the job site.



There is a WEDA pump for any dewatering application

We understand the dewatering needs of our customers, which vary with location and application. Accordingly our submersible range is developed for drainage (D), sludge (S) and slurry (L) applications.

These applications call for pumps designed specifically for handling corrosive and abrasive media and their solid contents.

Drainage pumps (WEDA D)	Sludge pumps (WEDA S)	Slurry pumps (WEDA L)
		
 <p>WATER DENSITY UP TO 1100 kg/m³</p>	 <p>WATER DENSITY UP TO 1400 kg/m³</p>	 <p>WATER DENSITY UP TO 1700 kg/m³</p>
 <p>DESIGN TOP DISCHARGE</p>	 <p>DESIGN BOTTOM SIDE DISCHARGE</p>	 <p>DESIGN BOTTOM SIDE AND TOP DISCHARGE</p>
 <p>SOLIDS HANDLING 4-12 mm</p>	 <p>SOLIDS HANDLING 25-50 mm</p>	 <p>SOLIDS HANDLING 20-60 mm</p>
 <p>pH VALUES FROM 5 TO 8</p>	 <p>pH VALUES FROM 5 TO 8</p>	 <p>pH VALUES FROM 2 TO 10</p>

Applications

- General dewatering
- Ground water
- Raw water
- Construction sites
- Water containing mud
- Sludge or light slurry
- Tank clean-out
- Trench and pond cleaning
- Mining
- Abrasive media with high solids content
- Quarries
- Dredging
- Settling ponds

WEDA D range

The WEDA drainage pumps handle either clean or dirty water, even with small solids with the best performance and efficiency.

HIGH CORROSION RESISTANCE

Unique aluminum alloy offers the perfect combination of strength, light weight and corrosion resistance

FLEXIBILITY

Discharges can be mounted vertically or sideways as required

MOTOR PROTECTION

Class F motors, with thermal switches in each winding

EXTENDED PERFORMANCE

Pump design ensures all-round motor cooling for better performance

WEDA+

1. Rotation control
2. Phase failure protection
3. Thermal switches
4. Phase shifter plugs for three-phase pumps

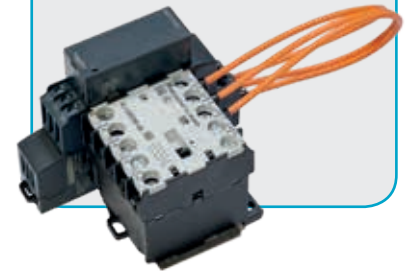

IMPROVED CABLE SEALING

Ensures protection against water leakage from cable entry

MODULAR SEALING SOLUTION

Based on pump size, the sealing system is adapted to provide the best solution

IMPROVED WEAR RESISTANCE

High-chrome (55HRC) impellers provide higher wear resistance

55 HRC

WEDA S range

The WEDA sludge pumps can handle thick, soft, wet mud or other similarly viscous mixtures of liquids and solids, especially the product of an industrial or refining process.

IMPROVED CABLE SEALING

Ensures protection against water leakage from cable entry

DRY RUNNING CAPABILITIES

Improved rib design offers external cooling to motor for extended running time

MOTOR PROTECTION

Class F motors, with thermal switches in each winding

HIGHER SOLIDS HANDLING

Sludge pumps can handle solids up to 50 mm

 **SOLIDS HANDLING**
25–50_{mm}

ROBUST DESIGN

Base of the pump ensures stability while enabling passage of large solids

WEDA+

1. Rotation control
2. Phase failure protection
3. Thermal switches
4. Phase shifter plugs for three-phase pumps

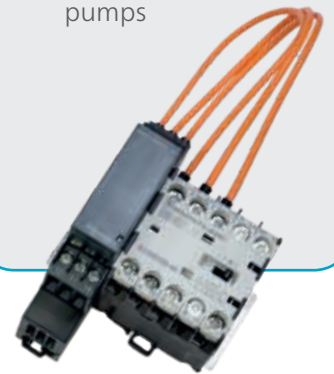

EASY INSPECTION

External oil inspection plug for quick inspection of oil

MODULAR SEALING SOLUTION

Based on pump size, the sealing system is adapted to provide the best solution

SUSTAINABLE PERFORMANCE

High-chrome (55HRC) impellers provide higher wear resistance

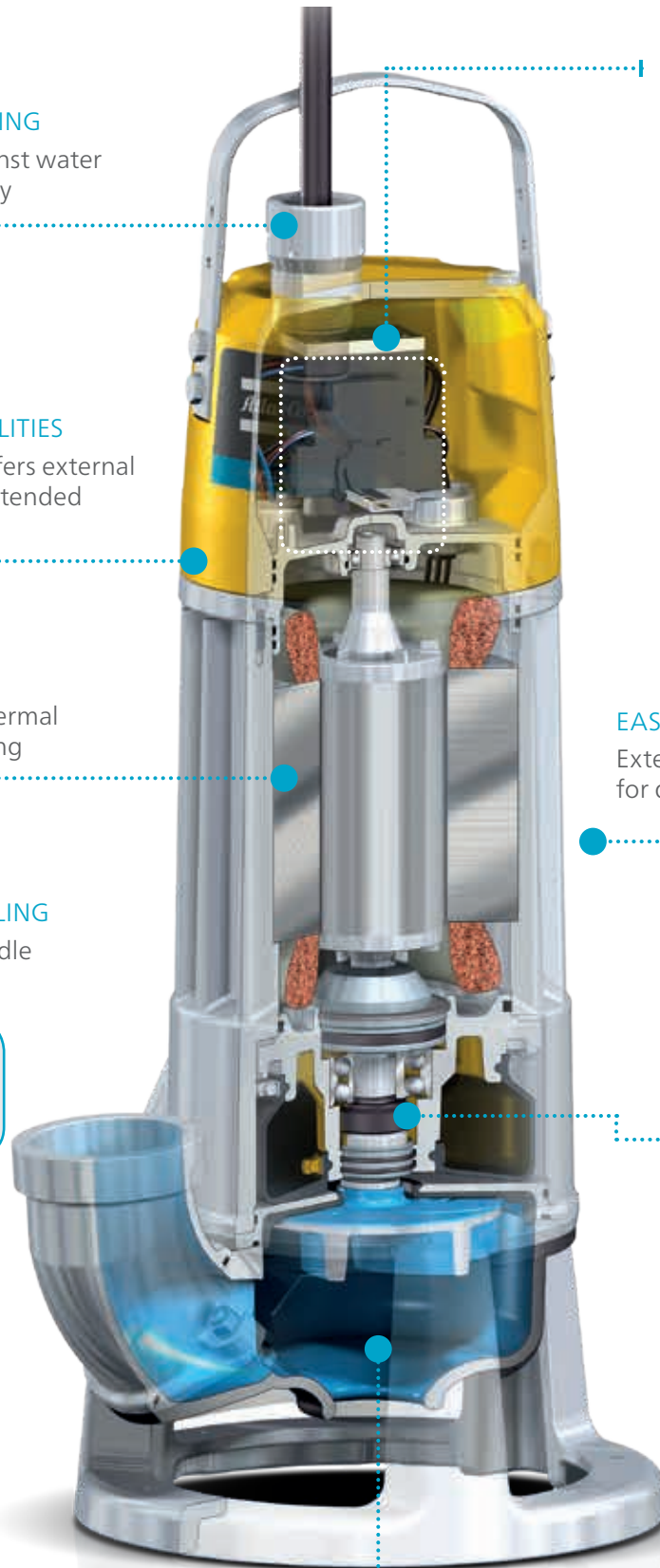

WEDA L range

The WEDA slurry pumps are the toughest, and have the largest apertures to facilitate handling of slurry with the most challenging solids.

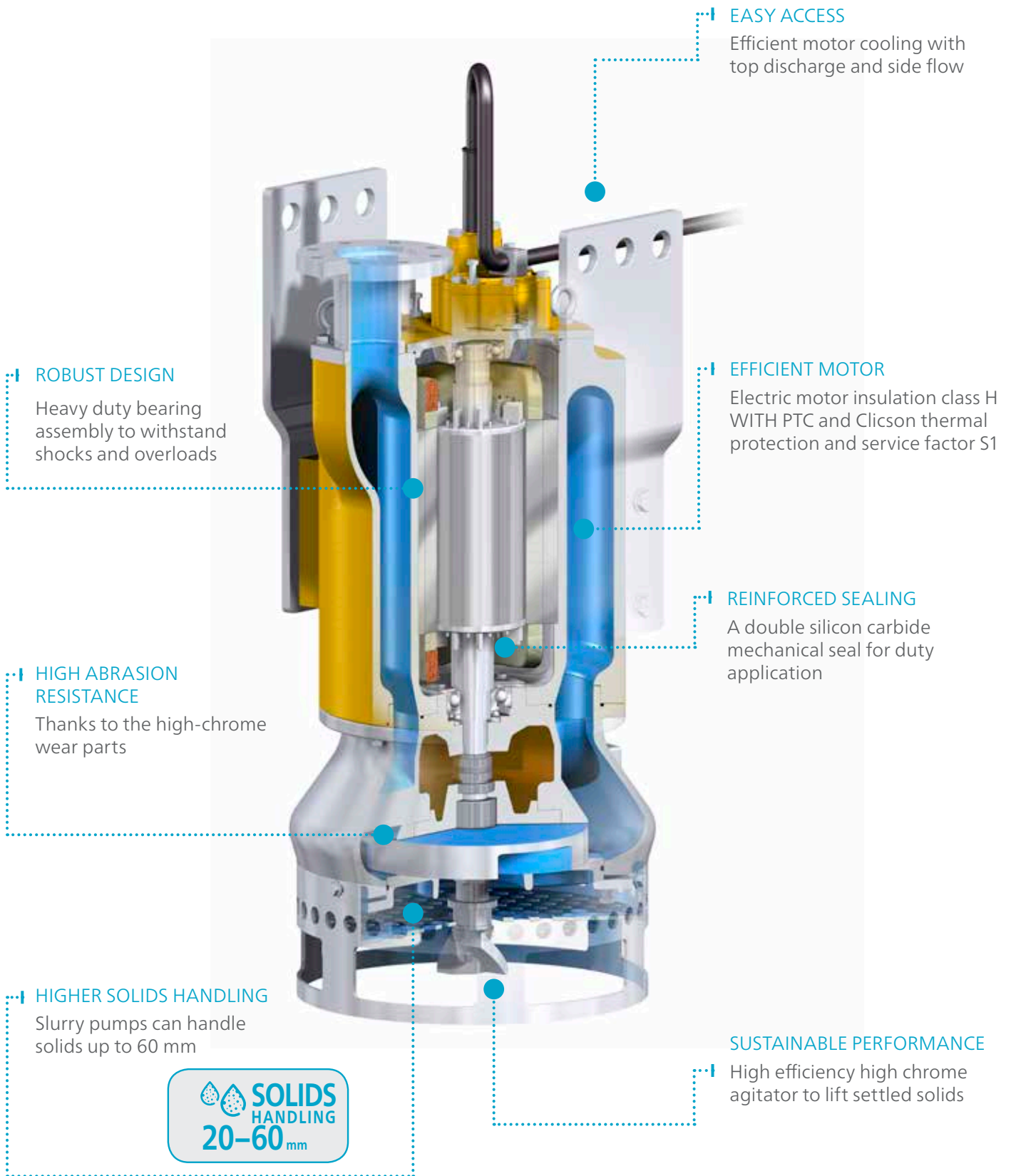

The Atlas Copco logo is positioned in the top right corner of the page. It consists of the company name "Atlas Copco" in a blue, italicized serif font, centered between two horizontal teal bars. The background of the entire page is a photograph of an orange excavator working in a muddy, industrial environment. In the foreground, a yellow submersible pump is partially submerged in a body of water, with a large pipe extending from it. A white diagonal overlay in the bottom left corner contains technical drawings of a pump component.

Atlas Copco

Tough environments demand tough pumps

The unique aluminum alloy construction of the WEDA pumps provides high corrosion resistance in a wide range of applications.

WEDA D range

Technical data



		WEDA D04N	WEDA D04BN	WEDA D08N	WEDA D10N		WEDA D30L		WEDA D30N		WEDA D40N
Specifications		1ph	1ph	1ph	1ph	3ph	1ph	3ph	1ph	3ph	3ph
Max. head	m	11,3	12,0	15,2	15,0	15,0	16,5	16,5	23	23	21
Max. flow	l/min	250	224	325	470	480	1250	1250	850	850	1320
	m ³ /h	15,0	13,5	19,5	28	29	75	75	51	51	79
Rated output	kW	0,40	0,40	0,8	1,0	1,0	2,0	2,0	2,0	2,0	3,0
Max. power input	kW	0,65	0,65	1,2	1,2	1,2	2,6	2,5	2,6	2,5	3,4
Discharge connection	in	2"	1" (2" optional)	2"	2"	2"	3" (4")	3" (4")	3" (4")	3" (4")	3" (4")
Max solids handling size	mm	7,5	4,5	7,5	4	4	7	7	7	7	7
Weight and dimensions											
Weight	kg	9,0	9,5	12,4	12,5	12,5	20	20	20	20	25
Height	mm	340	415	358	372	372	503	503	476	476	503
Width	mm	209	253	210	222	222	286	286	286	286	286
Diameter	mm	182	220	183	183	183	220	220	220	220	220

Typical applications

- General construction
- Mining
- Tunneling

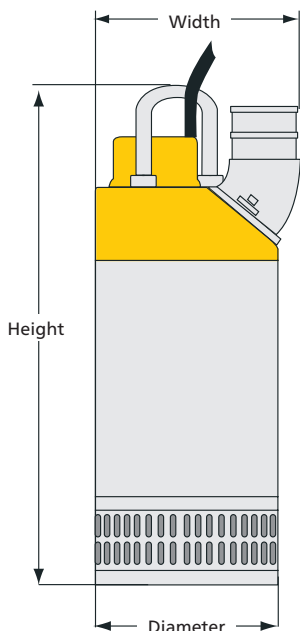

Performance curves

WEDA D04N

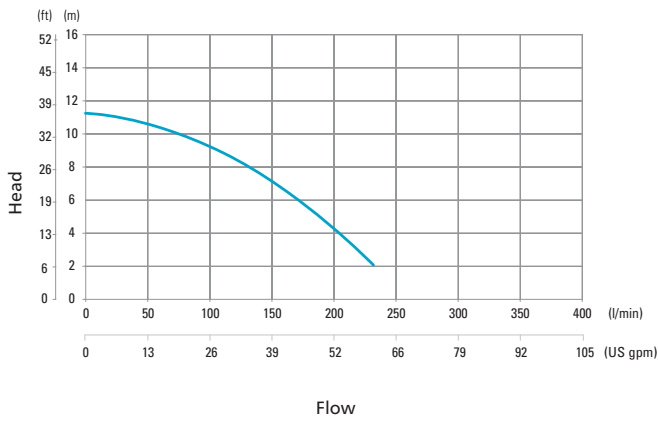

WEDA D04BN

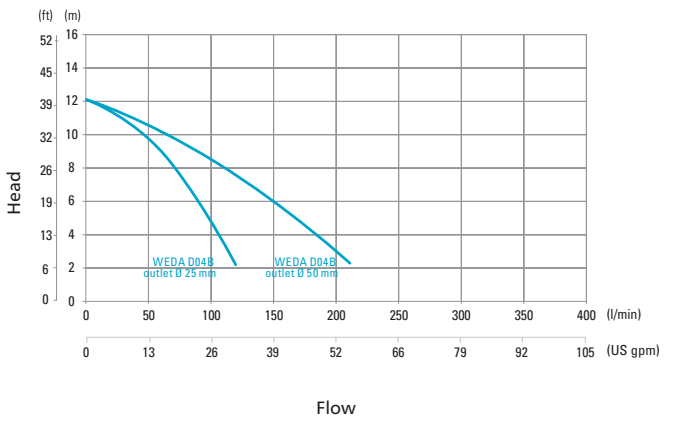

WEDA D08N

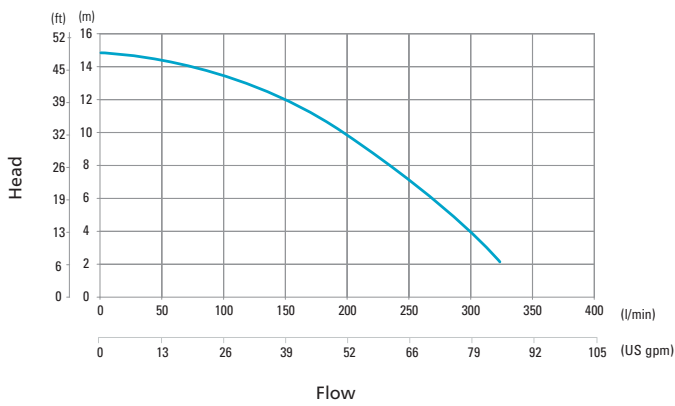

WEDA D10N

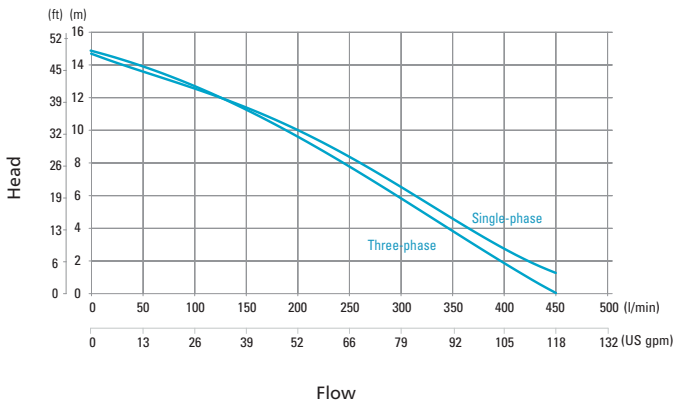

WEDA D30L, D30N

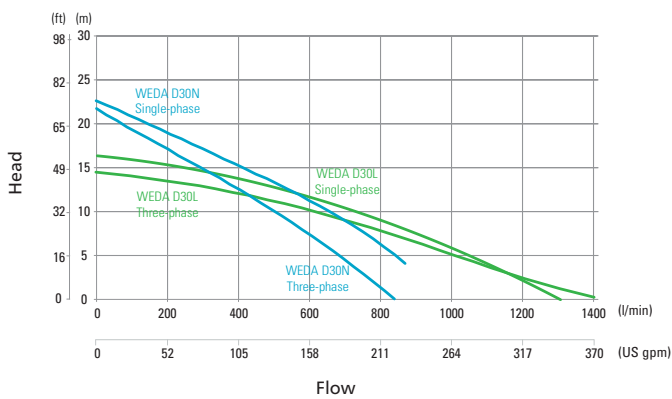

WEDA D40N

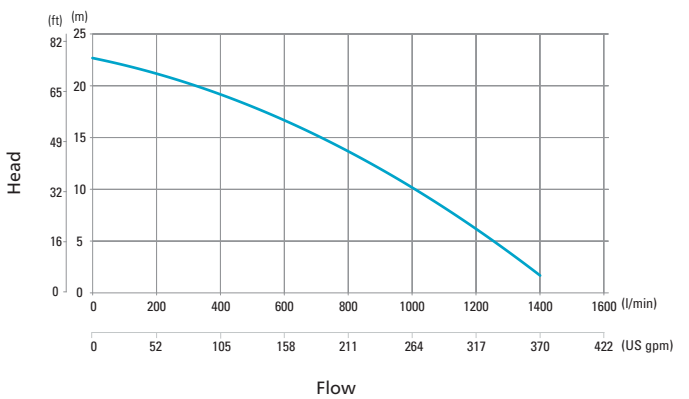

— Normal head
— Low head

According to ISO 9906 – ANNEX A

WEDA D range

Technical data



		WEDA D50N	WEDA D50H	WEDA D60N	WEDA D60H	WEDA D60SH	WEDA D70L	WEDA D70H	WEDA D80N	WEDA D80H	WEDA D90L	WEDA D90H	WEDA D100N
Specifications		3ph	3ph	3ph	3ph	3ph	3ph	3ph	3ph	3ph	3ph	3ph	3ph
Max. head	m	24	39	29	38	60	32	65	40	65	46	96	43
Max. flow	l/min	2300	1200	2600	1500	1050	4750	1583	6000	2500	6777	2111	16.200
	m ³ /h	138	72	156	90	63	285	95	360	150	407	127	972
Rated output	kW	5,6	5,6	7,5	7,5	7,5	11,8	11,8	20	20	26,5	26,5	54
Max. power input	kW	6,6	6,6	8,8	8,8	8,8	14,0	13,8	22	22	29,3	29,3	65
Discharge connection	in	4" (3")	3" (4")	4" (3")	3" (4")	3" (4")	6" (4")	4" (6")	6" (4")	4" (6")	6" (4")	4" (6")	10"
Max solids handling size	mm	8	8	8	8	8	7	7	12	12	7	7	12
Weight and dimensions													
Weight	kg	56	55	61	61	62	95	95	180	180	180	180	510
Height	mm	720	720	760	760	760	911	911	980	980	1058	1058	1412
Width	mm	330	302	330	302	302	395	395	690	665	437	437	650
Diameter	mm	278	278	278	278	278	360	360	530	530	401	401	600

Typical applications

- General construction
- Mining
- Tunneling

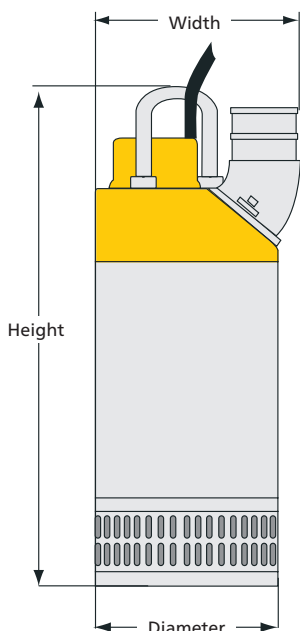

Performance curves

WEDA D50N, D50H

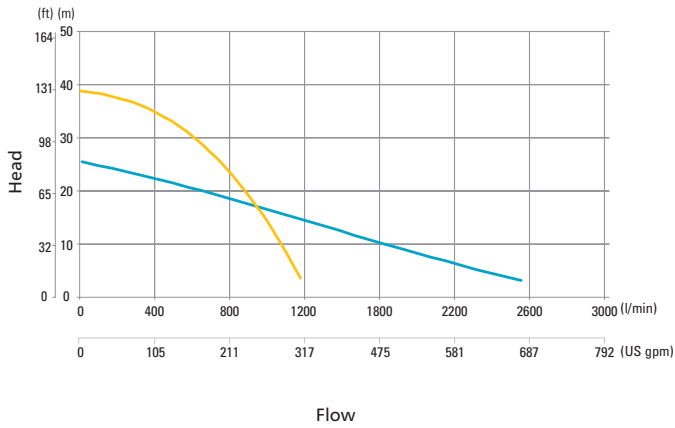

WEDA D60N, D60H, D60SH

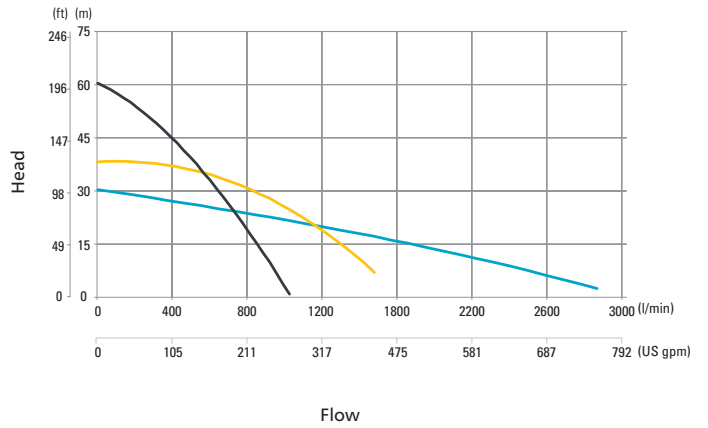

WEDA D70L, D70H

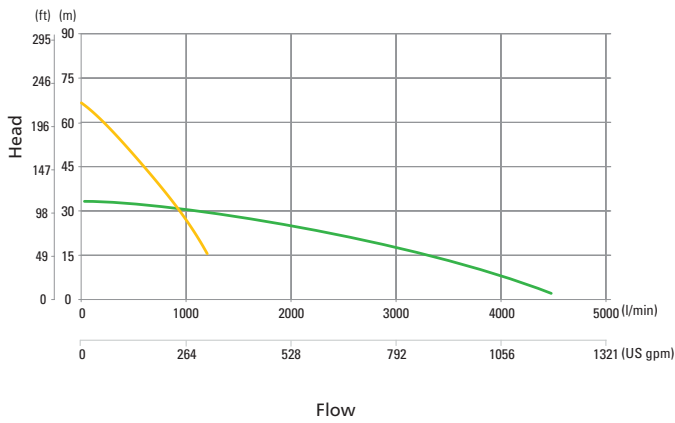

WEDA D80N, D80H

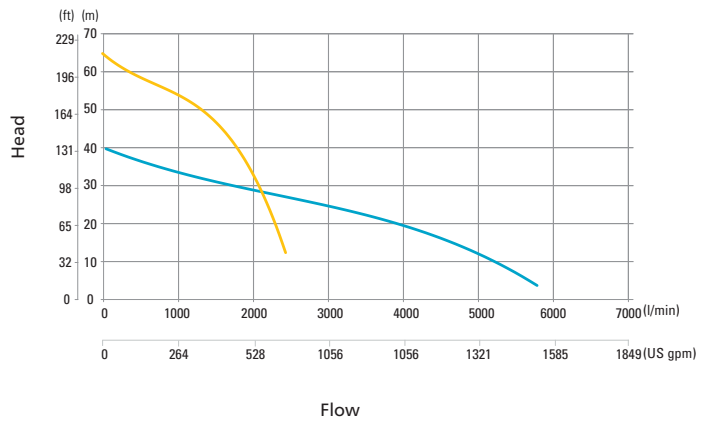

WEDA D90L, D90H

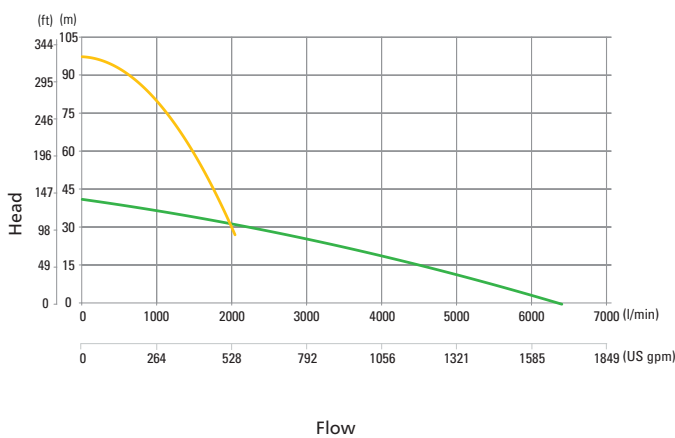

WEDA D100N

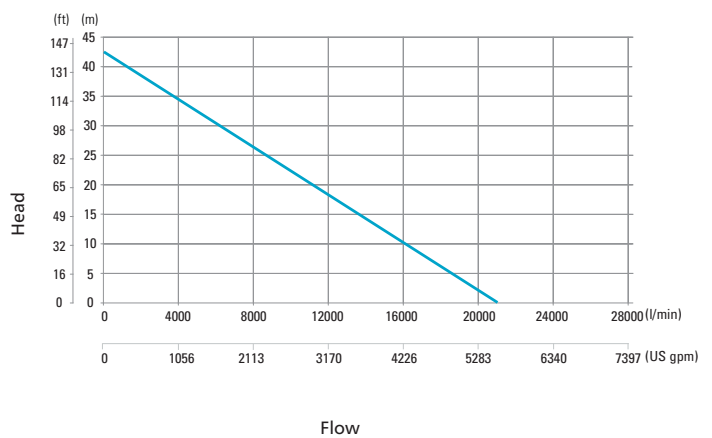

- Super high head
- High head
- Normal head
- Low head

According to ISO 9906 – ANNEX A

WEDA S range

Technical data



		WEDA S04N	WEDA S08N	WEDA S30N		WEDA S60N
Specifications		1ph	1ph	1ph	3ph	3ph
Max. head	m	10,5	13,0	12,5	15	25
Max. flow	l/min	270	317	700	900	1750
	m ³ /h	16,2	19,0	45	54	420
Rated output	kW	0,40	0,75	1,8	2,5	6,9
Max. power input	kW	0,65	1,2	2,2	3,3	8,0
Discharge connection	in	2"	2"	3"	3"	4" (3")
Max solids handling size	mm	25	25	50	50	50
Weight and dimensions						
Weight	kg	10	13	25	25	65
Height	mm	375	416	620	620	870
Width	mm	277	277	326	326	450
Diameter	mm	241	241	250	250	350

Typical applications

- Mining
- Construction sites
- Industries

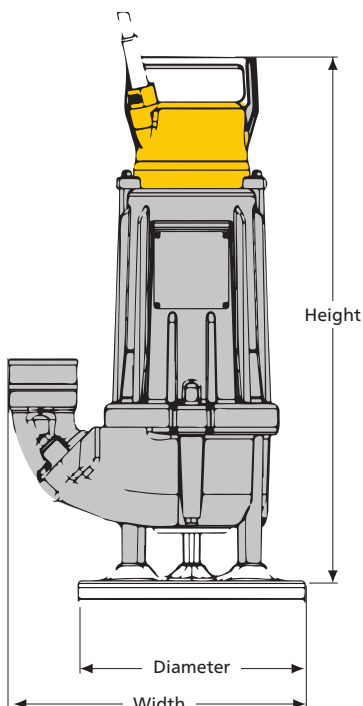

Performance curves

 WEDA S04N

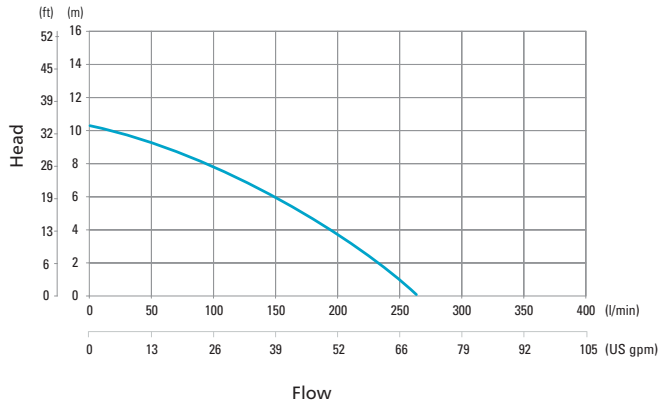

 WEDA S08N

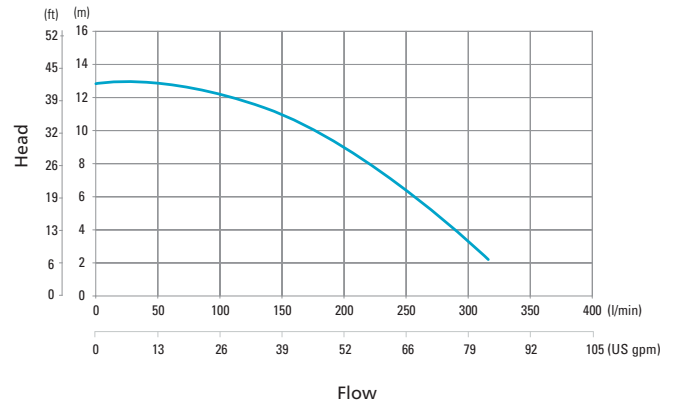

 WEDA S30N

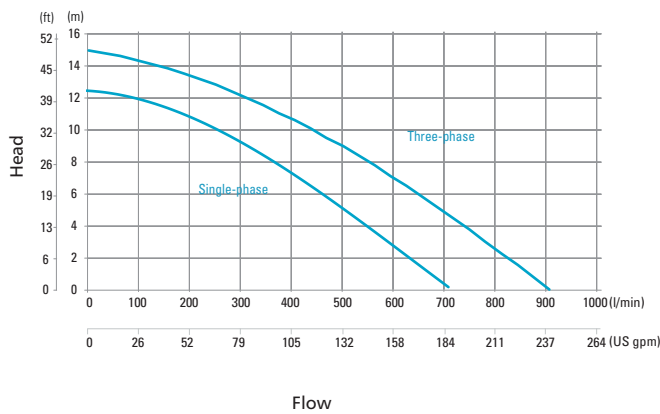

 WEDA S60N

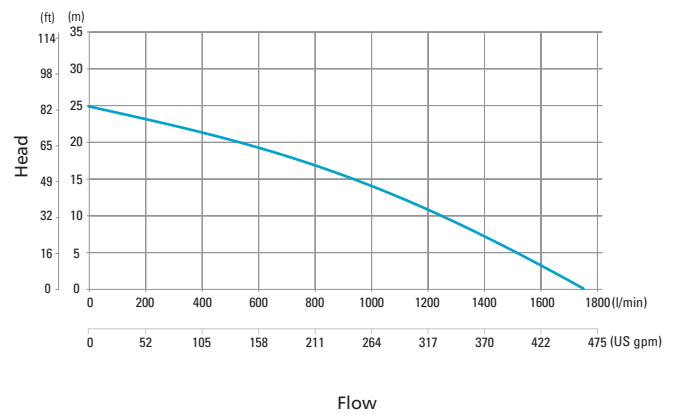

— Normal head

WEDA L range

Technical data



		WEDA L40N	WEDA L50N	WEDA L60N	WEDA L70N	WEDA L80N	WEDA L95N	WEDA L100N	WEDA L110N
Specifications		3ph	3ph	3ph	3ph	3ph	3ph	3ph	3ph
Max. head	m	13,4	17,0	22,8	24	27	51	30	50
Max. flow	l/min	1134	1667	2334	2500	2667	4667	7251	9169
	m ³ /h	68	70	140	150	160	280	435	550
Rated output	kW	3,70	5,50	9,0	11,0	15,0	37	45	75
Max. power input	kW	4,5	6,8	10,4	12,8	16,1	40,1	48,8	79,9
Discharge connection	in	3	4	4	4	4	4	6	6
Max solids handling size	mm	20	25	25	25	25	35	60	60
Weight and dimensions									
Weight	kg	185	260	260	270	310	750	1005	1070
Height	mm	793	914	914	914	1080	1605	1605	1605
Width	mm	388	435	435	435	580	935	935	935
Diameter	mm	337	413	413	413	495	546	546	546

Typical applications

- Quarries
- Mining
- Settling ponds

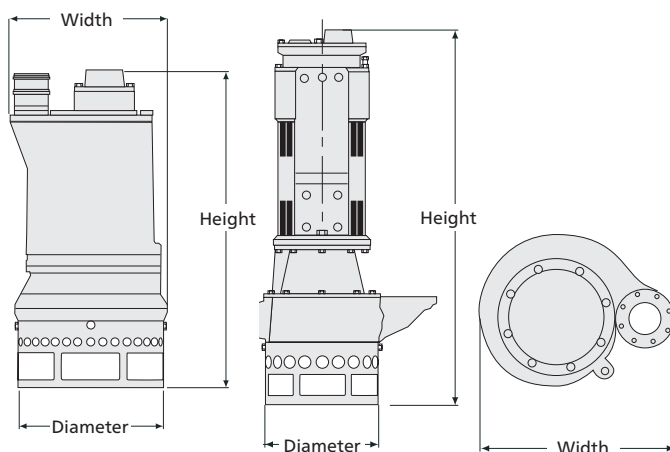

Performance curves

WEDA L40N

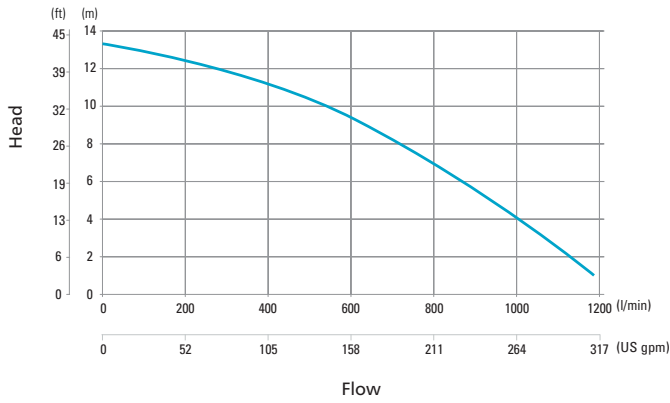

WEDA L50N

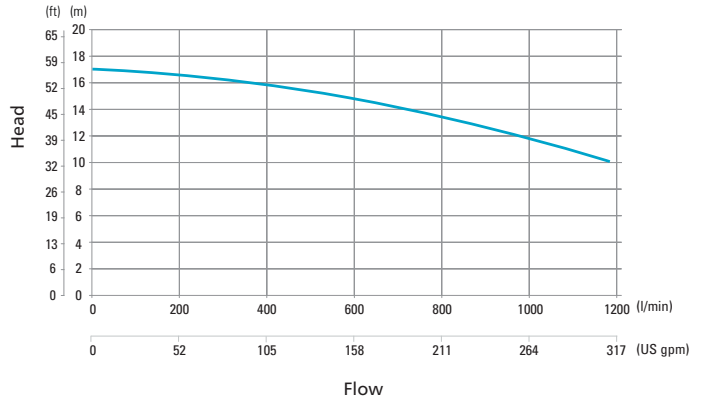

WEDA L60N

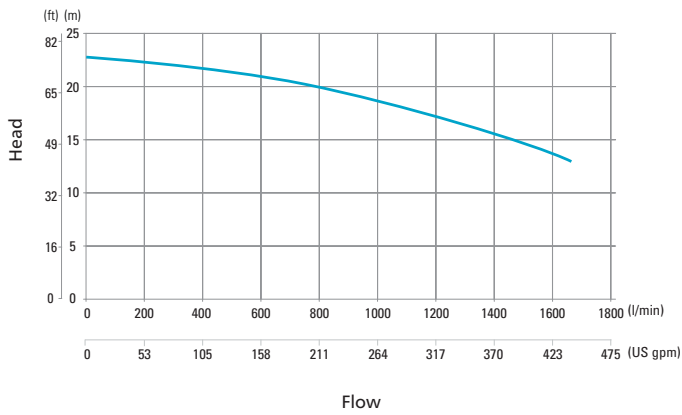

WEDA L70N

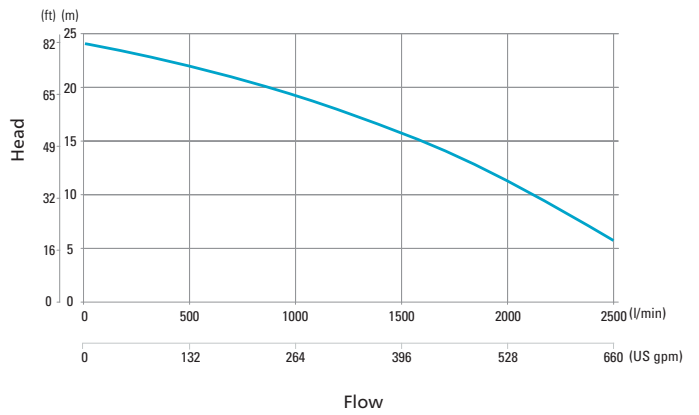

WEDA L80N

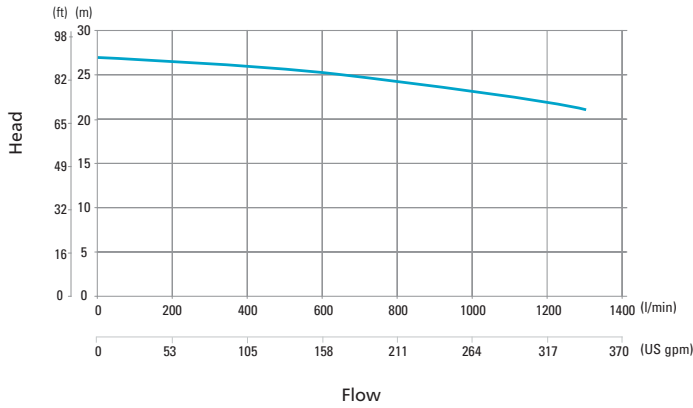

WEDA L95N

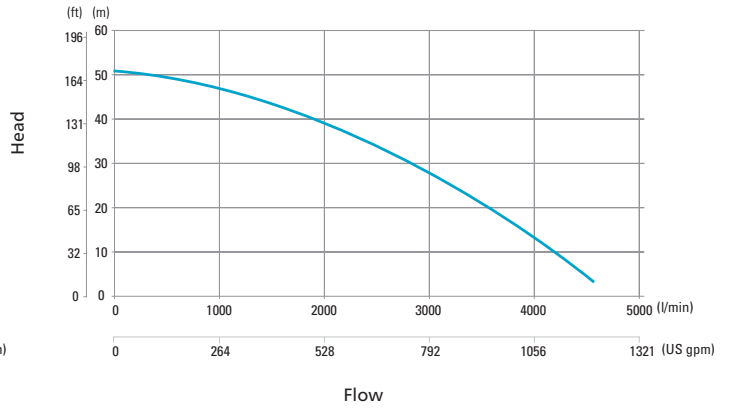

WEDA L100N

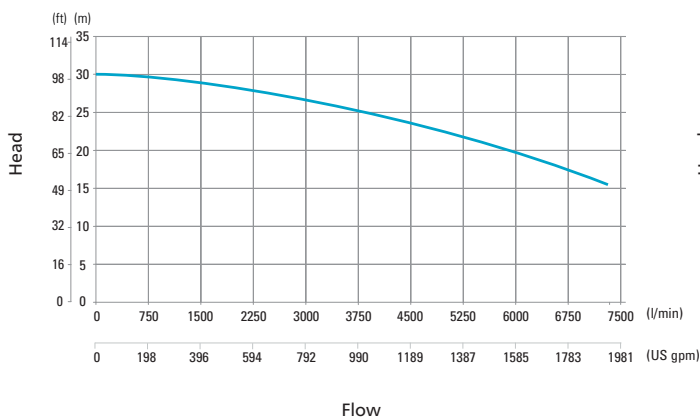

WEDA L110N

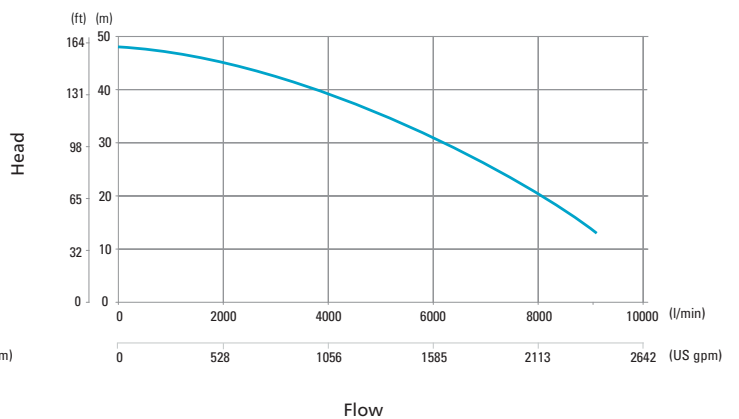

— Normal head

Accessories

Discharge connections

We understand that you will have preferred equipment connections, so we offer four types. All can be mounted in either a vertical or horizontal position.

- Hose



- Storz



- ISO-G



- NPT



Level regulators

For easy control of water level by automatic pump switch-on/-off:

- Float switch



Zinc anodes

Specifically required for pumping water with a high concentration of salts such as sea water, brine, etc.



Low suction collar

To easily drain the water level down to the floor.

Hoses

Multiple hose options with a variety of end connections are available in different lengths ready in stock.

Epoxy coating

For additional protection against corrosion.

Service kits

Seal kit

The seal kit is the proper selection of high quality components for a mechanical seal change to ensure trouble-free operation after servicing.

- O-ring kit
- Mechanical shaft seal



Instant service pack

The instant service pack is a preassembled, tested and ready-to-use seal system containing the mechanical shaft seals, bearings, gaskets and oil to ensure trouble-free operation. It offers a quick onsite repair option due to ease of installation and therefore reduces the machine downtime cost.



Wear part kit

The wear part kit is a typical selection of components to bring the pump performance back to factory standard. The ideal solution for a machine overhaul or refurbishment.

- Impeller
- Wear plate
- Wear plate gasket
- Wear plate fixings
- Shaft key
- Impeller nut
- Rear wear plate*



The Atlas Copco logo is positioned in the top right corner of the image. It consists of the brand name "Atlas Copco" in a blue, serif font, centered between two horizontal blue bars. The background of the entire image is a photograph of a large industrial machine, a concrete pump, being lowered into a stone building's opening. The machine has a yellow upper section and a grey, perforated lower section. A technical drawing of the machine's circular components is overlaid in the bottom left corner, showing various dimensions and labels like "C-C(13)", "072", "070", "071", "073", "074", "075", "076", "077", "078", "079", "080", "081", "082", "083", "084", "085", "086", "087", "088", "089", "090", "091", "092", "093", "094", "095", "096", "097", "098", "099", "100", "101", "102", "103", "104", "105", "106", "107", "108", "109", "110", "111", "112", "113", "114", "115", "116", "117", "118", "119", "120", "121", "122", "123", "124", "125", "126", "127", "128", "129", "130", "131", "132", "133", "134", "135", "136", "137", "138", "139", "140", "141", "142", "143", "144", "145", "146", "147", "148", "149", "150", "151", "152", "153", "154", "155", "156", "157", "158", "159", "160", "161", "162", "163", "164", "165", "166", "167", "168", "169", "170", "171", "172", "173", "174", "175", "176", "177", "178", "179", "180", "181", "182", "183", "184", "185", "186", "187", "188", "189", "190", "191", "192", "193", "194", "195", "196", "197", "198", "199", "200", "201", "202", "203", "204", "205", "206", "207", "208", "209", "210", "211", "212", "213", "214", "215", "216", "217", "218", "219", "220", "221", "222", "223", "224", "225", "226", "227", "228", "229", "230", "231", "232", "233", "234", "235", "236", "237", "238", "239", "240", "241", "242", "243", "244", "245", "246", "247", "248", "249", "250", "251", "252", "253", "254", "255", "256", "257", "258", "259", "260", "261", "262", "263", "264", "265", "266", "267", "268", "269", "270", "271", "272", "273", "274", "275", "276", "277", "278", "279", "280", "281", "282", "283", "284", "285", "286", "287", "288", "289", "290", "291", "292", "293", "294", "295", "296", "297", "298", "299", "300", "301", "302", "303", "304", "305", "306", "307", "308", "309", "310", "311", "312", "313", "314", "315", "316", "317", "318", "319", "320", "321", "322", "323", "324", "325", "326", "327", "328", "329", "330", "331", "332", "333", "334", "335", "336", "337", "338", "339", "340", "341", "342", "343", "344", "345", "346", "347", "348", "349", "350", "351", "352", "353", "354", "355", "356", "357", "358", "359", "360", "361", "362", "363", "364", "365", "366", "367", "368", "369", "370", "371", "372", "373", "374", "375", "376", "377", "378", "379", "380", "381", "382", "383", "384", "385", "386", "387", "388", "389", "390", "391", "392", "393", "394", "395", "396", "397", "398", "399", "400", "401", "402", "403", "404", "405", "406", "407", "408", "409", "410", "411", "412", "413", "414", "415", "416", "417", "418", "419", "420", "421", "422", "423", "424", "425", "426", "427", "428", "429", "430", "431", "432", "433", "434", "435", "436", "437", "438", "439", "440", "441", "442", "443", "444", "445", "446", "447", "448", "449", "450", "451", "452", "453", "454", "455", "456", "457", "458", "459", "460", "461", "462", "463", "464", "465", "466", "467", "468", "469", "470", "471", "472", "473", "474", "475", "476", "477", "478", "479", "480", "481", "482", "483", "484", "485", "486", "487", "488", "489", "490", "491", "492", "493", "494", "495", "496", "497", "498", "499", "500", "501", "502", "503", "504", "505", "506", "507", "508", "509", "510", "511", "512", "513", "514", "515", "516", "517", "518", "519", "520", "521", "522", "523", "524", "525", "526", "527", "528", "529", "530", "531", "532", "533", "534", "535", "536", "537", "538", "539", "540", "541", "542", "543", "544", "545", "546", "547", "548", "549", "550", "551", "552", "553", "554", "555", "556", "557", "558", "559", "560", "561", "562", "563", "564", "565", "566", "567", "568", "569", "570", "571", "572", "573", "574", "575", "576", "577", "578", "579", "580", "581", "582", "583", "584", "585", "586", "587", "588", "589", "590", "591", "592", "593", "594", "595", "596", "597", "598", "599", "600", "601", "602", "603", "604", "605", "606", "607", "608", "609", "610", "611", "612", "613", "614", "615", "616", "617", "618", "619", "620", "621", "622", "623", "624", "625", "626", "627", "628", "629", "630", "631", "632", "633", "634", "635", "636", "637", "638", "639", "640", "641", "642", "643", "644", "645", "646", "647", "648", "649", "650", "651", "652", "653", "654", "655", "656", "657", "658", "659", "660", "661", "662", "663", "664", "665", "666", "667", "668", "669", "670", "671", "672", "673", "674", "675", "676", "677", "678", "679", "680", "681", "682", "683", "684", "685", "686", "687", "688", "689", "690", "691", "692", "693", "694", "695", "696", "697", "698", "699", "700", "701", "702", "703", "704", "705", "706", "707", "708", "709", "710", "711", "712", "713", "714", "715", "716", "717", "718", "719", "720", "721", "722", "723", "724", "725", "726", "727", "728", "729", "730", "731", "732", "733", "734", "735", "736", "737", "738", "739", "740", "741", "742", "743", "744", "745", "746", "747", "748", "749", "750", "751", "752", "753", "754", "755", "756", "757", "758", "759", "760", "761", "762", "763", "764", "765", "766", "767", "768", "769", "770", "771", "772", "773", "774", "775", "776", "777", "778", "779", "780", "781", "782", "783", "784", "785", "786", "787", "788", "789", "790", "791", "792", "793", "794", "795", "796", "797", "798", "799", "800", "801", "802", "803", "804", "805", "806", "807", "808", "809", "810", "811", "812", "813", "814", "815", "816", "817", "818", "819", "820", "821", "822", "823", "824", "825", "826", "827", "828", "829", "830", "831", "832", "833", "834", "835", "836", "837", "838", "839", "840", "841", "842", "843", "844", "845", "846", "847", "848", "849", "850", "851", "852", "853", "854", "855", "856", "857", "858", "859", "860", "861", "862", "863", "864", "865", "866", "867", "868", "869", "870", "871", "872", "873", "874", "875", "876", "877", "878", "879", "880", "881", "882", "883", "884", "885", "886", "887", "888", "889", "890", "891", "892", "893", "894", "895", "896", "897", "898", "899", "900", "901", "902", "903", "904", "905", "906", "907", "908", "909", "910", "911", "912", "913", "914", "915", "916", "917", "918", "919", "920", "921", "922", "923", "924", "925", "926", "927", "928", "929", "930", "931", "932", "933", "934", "935", "936", "937", "938", "939", "940", "941", "942", "943", "944", "945", "946", "947", "948", "949", "950", "951", "952", "953", "954", "955", "956", "957", "958", "959", "960", "961", "962", "963", "964", "965", "966", "967", "968", "969", "970", "971", "972", "973", "974", "975", "976", "977", "978", "979", "980", "981", "982", "983", "984", "985", "986", "987", "988", "989", "990", "991", "992", "993", "994", "995", "996", "997", "998", "999", "1000".A technical drawing of a circular component is overlaid in the bottom left corner. It shows a cross-section of a cylinder with various dimensions and labels. The drawing is in blue lines on a white background. The main text "Built better. Built to resist and perform" is overlaid on the drawing.

Built better. Built to resist and perform

DIP pneumatic pump

A pneumatic pump is a great choice when failure is not an option. They're easy to use, safe and can handle almost anything you throw at them.

The DIP centrifugal pumps can be made to suit several operations. With a simple change of impeller and intake ring you can adjust to the desired capacity and head. That means you get a three-in-one solution. The DIP is designed to handle relatively clean low-viscosity liquids such as water and cooling fluids.

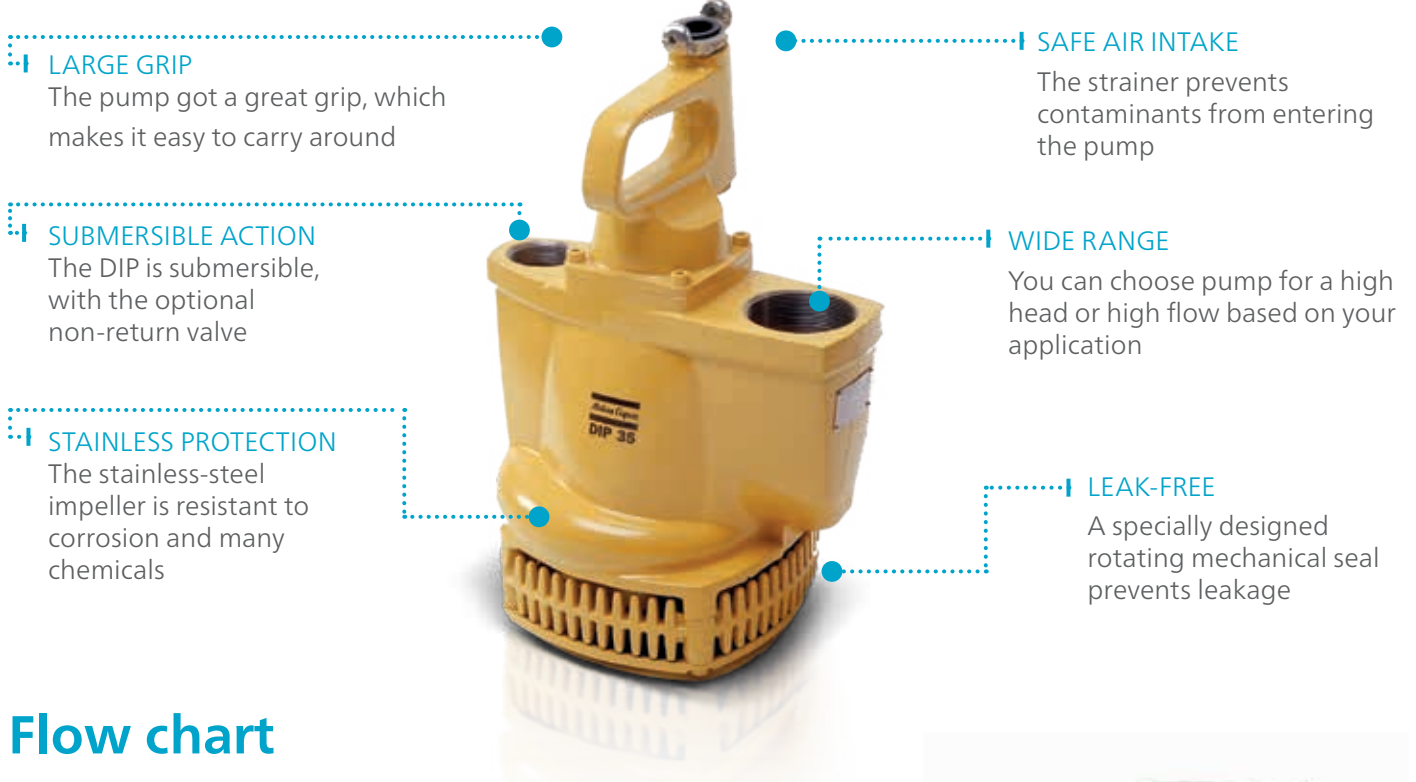

LARGE GRIP
The pump got a great grip, which makes it easy to carry around

SUBMERSIBLE ACTION
The DIP is submersible, with the optional non-return valve

STAINLESS PROTECTION
The stainless-steel impeller is resistant to corrosion and many chemicals

SAFE AIR INTAKE
The strainer prevents contaminants from entering the pump

WIDE RANGE
You can choose pump for a high head or high flow based on your application

LEAK-FREE
A specially designed rotating mechanical seal prevents leakage

Flow chart

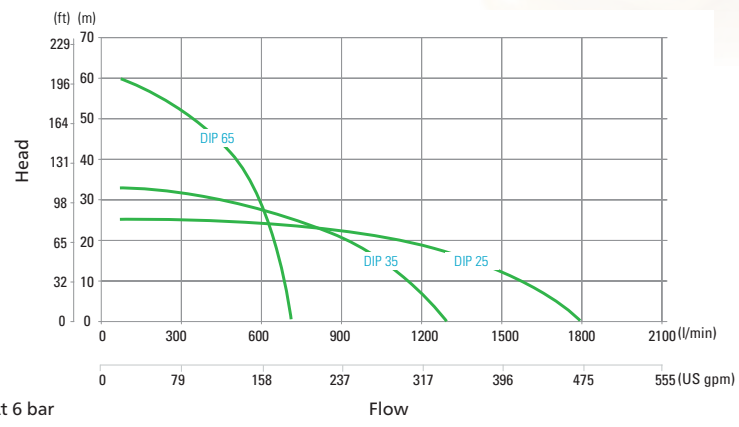

Specifications			DIP 25	DIP 35	DIP 65
Max. head		m	25	35	59
Max. flow		l/min	1680	1320	660
Max. flow		m ³ /h	270 58,1	79,2	39,6
Max. air requirements		l/s	70	70	70
Connection thread ¹	Fluid outlet	in	G 2 1/2	G 2 1/2	G 2 1/2
	Air inlet	in	G 3/4	G 3/4	G 3/4
	Air outlet	in	G 1 1/2	G 1 1/2	G 1 1/2
Weight and dimensions					
Weight		kg	23	23	23
Length		mm	235	235	235
Width		mm	288	288	288
Height		mm	435	435	435

DOP pneumatic pump

When the going gets tough, the tough get a DOP diaphragm pump. They are designed for the most polluted and viscous media, as well as highly abrasive and flammable fluids.

EASY TO HANDLE

It only takes one person to handle the DOP

SAFE INTAKE

The air intake with strainer prevents contaminants from entering the pump via the air

SELF-PRIMING

Reduces unnecessary handling in rough environments

REACH THE CORNERS

Thanks to the pivoting intake coupling together with an optional suction hose

SUBMERSIBLE

The built-in non-return valve makes the pump submersible and independent of orientation; add a silencer for lower noise levels

LIFT MORE

The DOP can be connected in series to increase the lifting capacity, or "head"

PIVOTING CONNECTION

Reduces stress on the hose

STABLE OPERATIONS

The strainer at the base prevents particles larger than 30 mm from passing through the pump



Flow chart

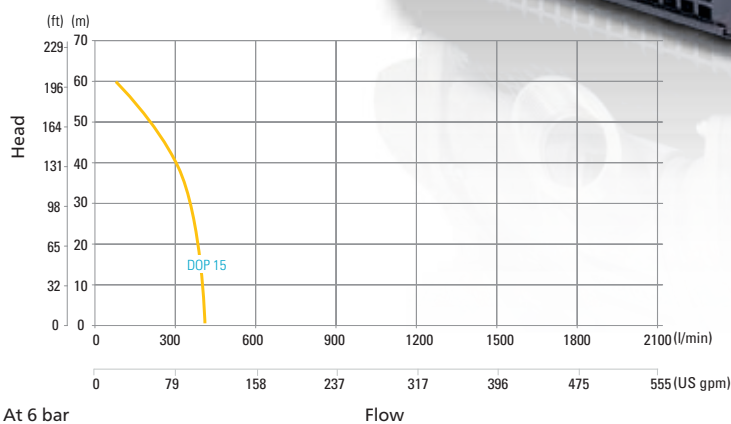

Specifications			DOP 15N	DOP 15F
Max. head		m	59	59
Max. flow		l/min	420	420
Max. flow		m ³ /h	25,2	25,2
Max. air requirements		l/s	34	34
Connection thread ¹	Fluid outlet	in	G 2 1/2	G 2 1/2
	Air inlet	in	G 3/4	G 3/4
Weight and dimensions				
Weight		kg	31	31
Length		mm	390	390
Width		mm	330	330
Height		mm	585	585

Product portfolio

GENERATORS

PORTABLE
1,6–12 kVA



MOBILE
9–1250* kVA



INDUSTRIAL
10–2250* kVA



CONTAINERS
800–1450 kVA



*Multiple configurations available to produce power for any size application

DEWATERING PUMPS

ELECTRIC SUBMERSIBLE
250–23.300 l/min



SURFACE PUMPS
833–23.300 l/min



SMALL PORTABLE
210–2500 l/min



Diesel and electric options available

LIGHT TOWERS

DIESEL LED AND MH



BATTERY LED



ELECTRIC LED



AIR COMPRESSORS AND HANDHELD TOOLS

AIR COMPRESSORS
1–116 m³/min
7–345 bar



HANDHELD TOOLS
Pneumatic
Hydraulic
Petrol engine driven



ONLINE SOLUTIONS

**SHOP ONLINE
PARTS ONLINE**

Find and order the spare parts for power equipment. We handle your orders 24 hours a day.



POWER CONNECT

Scan the QR code on your machine, and go to the QR Connect Portal to find all the information about your machine.



FLEETLINK

Intelligent telematics system that helps optimize fleet usage, reduce maintenance costs, ultimately saving time and cost.

