



TRACKED EXCAVATOR | JZ140 LC/HD

Gross engine power: 81 kW (109 hp) | Bucket capacity: 0.35 – 0.89m³ | Operating weight: 15084 – 17880kg



STRENGTH IN DEPTH.

BUILT TO WITHSTAND THE RIGOURS OF LIFE ON ANY CONSTRUCTION SITE, THE NEW JCB JZ140 EXCAVATOR IS STRONGER THAN EVER. PUT SIMPLY, IT'S MADE FROM THE FINEST MATERIALS AND COMPONENTS, USING THE VERY LATEST MANUFACTURING ADVANCES.



The JCB JZ140 boasts the best components in the industry, including a JCB EcoMAX engine, Berco running gear, Kawasaki pumps and Kayaba main control valves.



1

Boom and dipper.

1 A JCB JZ140's reinforced boom and dipper is made of high strength steel, with internal baffle plates for long life durability.

2 Our advanced manufacturing and assembly processes produce high precision premium quality assembled components.



2

The sum of its parts.

3 Our engine is tried and proven; we've built 200,000 DIESELMAX engines since 2004. To ensure similar longevity; the JZ140's EcoMAX T4i/Stage IIIB engine has been tested for 110,000 hours in 70 different machines across the toughest applications and environments around the world.



3



Built to last.

- 4 The high-strength undercarriage of a JCB JZ140 uses a fully welded X-frame construction for long-term durability even in the most demanding applications.
- 5 A closed box section revolving frame increases strength and reduces stress. It's also highly resistant to impact damage.
- 6 The JZ140's high-strength rigid upper frame provides maximum durability and support, while its stiff durable door design offers you added strength and rigidity.
- 7 The JZ140 has a redesigned dozer blade design with a deeper section increasing stiffness and durability.

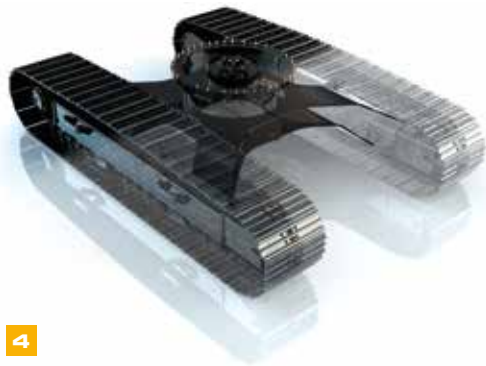

4



5



7



6

PERFORMANCE AND PRODUCTIVITY.

WE'VE DESIGNED THE NEW JCB JZ140 TO OFFER YOU UNPARALLELED LEVELS OF PERFORMANCE AND PRODUCTIVITY. THE LATEST ECOMAX ENGINE OFFERS YOU BOTH POWER AND EFFICIENCY, WHILE STATE-OF-THE-ART HYDRAULICS PROVIDE COLOSSAL FORCE AND PRECISION CONTROL AT THE DIG END.



There's a full list of auxiliary pipework options including hammer, auxiliary, and low flow. For ultra versatility, these auxiliary options are available with proportional controls.

Loads more productive.

- 1** JCB's all-new easy-to-use quickhitch system makes attachment changing quicker and easier for you, and is purpose-designed for the JS range.
- 2** An optional dozer blade increases versatility when you're grading. Choose the optional rubber street pads and you can use your JCB JZ140 on sensitive ground like tarmac without causing damage.

EcoMAX efficiency.

- 3** Our proven EcoMAX T4i/Stage IIIB engines are highly fuel efficient, saving you money. This is partly due to the fact that EcoMAX produces high torque at just 1500 - 1600 rpm, making for improved fuel-efficient matching of the hydraulics.

To reduce noise pollution from unnecessary air flow, the JZ140's engine-driven cooling fan has a proportional control system, maintaining optimum fan speed.

Variable power bands allow you to tailor performance, and therefore economy, to specific tasks.



Always in total control.

4 Simultaneous tracking and excavating is smooth and fast with an intuitive multi-function operation. Proportional controls offer you precise command over attachments and in tasks where you need to perform fine adjustments.

5 JCB's innovative hydraulic regeneration system means oil is recycled across the cylinders for faster cycle times and reduced fuel consumption.



4



5



With a massive 92kN bucket tearout and fast cycle times, this excavator is extremely productive in all applications.

A JCB JZ140 has a solid, stable work platform for fast cycle times.

REDUCED SWING, INCREASED SAFETY.

SAFETY IS OF COURSE THE NUMBER ONE PRIORITY ON ANY WORK SITE. THE NEW JCB JZ140 OFFERS YOU GREATER LEVELS OF SAFETY THAN A CONVENTIONAL TAILSWING EXCAVATOR DESIGN BECAUSE IT'S EASIER TO MANOEUVRE, ESPECIALLY IN RESTRICTED SPACES.



Safety without compromise.

1 A reduced tailswing configuration is perfect for working in urban environments or where space is at a premium. In short, JCB JZ140's reduced tailswing improves safety and increases operator confidence.

2 This excavator is tailor-made for applications like urban building sites, motorway work, house building, forestry, utilities, railways and commercial buildings.



Select the optional boxing ring to maximise safety when completing daily checks on the upper structure.



3

The safe choice.

3 Optional LED lighting improves visibility in low light conditions, boosting both safety and productivity.

5 The JCB JZ140 is fitted with a rear-view camera as standard to further increase on site safety.

Choose the optional seatbelt warning beacon available to meet your job site commitments.



4



COMFORTABLY SUPERIOR.

IN ORDER TO ENJOY ULTIMATE PRODUCTIVITY, YOU NEED YOUR OPERATORS TO STAY FRESH AND ALERT FOR LONG SHIFTS. THE CAB AND CONTROLS ON THE NEW JCB JZ140 ARE DESIGNED TO ACHIEVE JUST THAT, OFFERING AN INCREDIBLY INTUITIVE, ERGONOMIC AND COMFORTABLE WORKING ENVIRONMENT.

Total control.

- 1** A 70/30 front screen split gives JCB JZ140s excellent front visibility. A clear view of the front right track provides easy, safe trench digging and manoeuvring.
- 2** The 7" colour multi-function display is easy to read in all light conditions, provides instant operational information, and has a customisable home screen.
- 3** JCB's new basic tool select system (fitted as standard) allows the operator to set up the single direction auxiliary and hammer circuit to match the flow requirements. The selected flow is achieved by automatically adjusting the engine revs when the hydraulic service is operated.
- 4** A full sized cab delivers a spacious and comfortable operating environment.

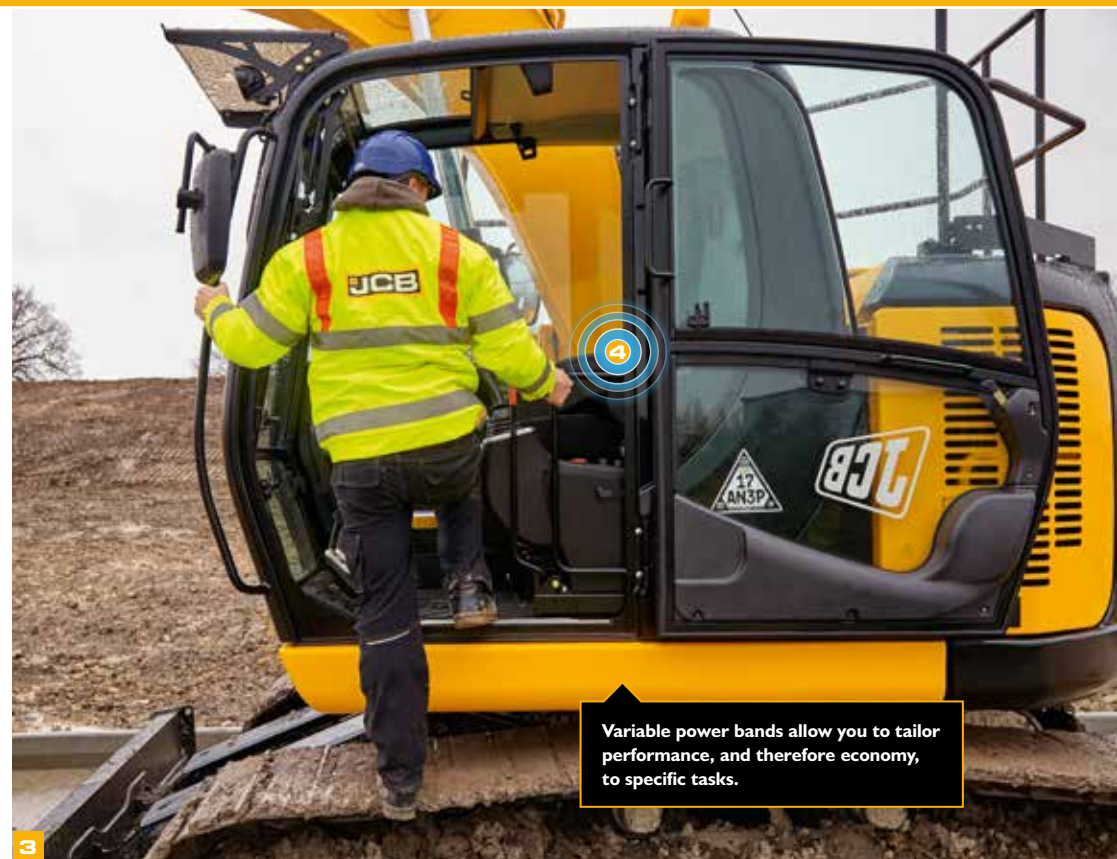

Variable power bands allow you to tailor performance, and therefore economy, to specific tasks.



A great place to work.

4 The JZ140 creates a quieter working environment inside and out. Because we've reduced noise levels to 72dB(A) inside and 99dB(A) outside, you can use the machine at any location, any time. JCB cabs use 6 viscous rubber mounts to minimise noise and vibration. The positive pressure cab keeps out dirt and dust.

JCB's climate control option offers a precisely controlled cab temperature with fresh or recirculated air. Demisting/defrosting functions keep a JZ140's front window clear.

5 There's a spacious luggage tray behind the operator's seat.

6 A large floor area with large high grip pedals gives easy and precise tracking.

The JCB JZ140 is now available with the Supreme seat. Featuring air suspension, lumbar support and a fully adjustable headrest. The supreme seat also features ventilation to keep you cool on hot days, and a heater for colder conditions.



5



6

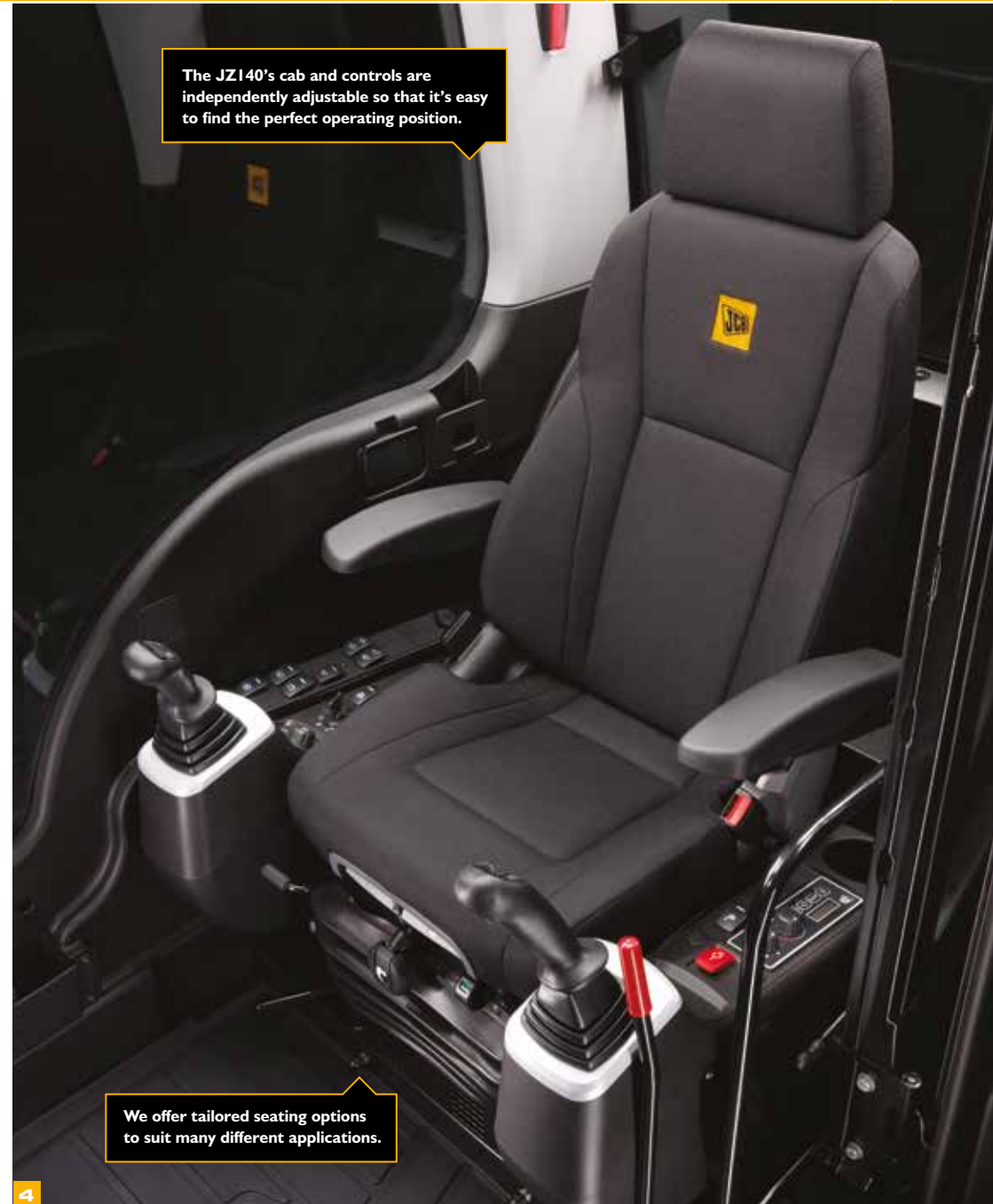

The JZ140's cab and controls are independently adjustable so that it's easy to find the perfect operating position.

We offer tailored seating options to suit many different applications.

4

LESS SERVICING, MORE SERVICE.

TO PROVIDE YOU WITH THE MAXIMUM POSSIBLE UPTIME, WE'VE MADE THE NEW JCB JZ140 AN EXTREMELY EASY EXCAVATOR TO SERVICE. WHEN MAINTENANCE IS REQUIRED, YOU'LL FIND IT'S QUICK AND COST-EFFECTIVE TO CARRY OUT THANKS TO THE COMPLETELY REDESIGNED UPPER STRUCTURE.

Access all areas.

1 All filters on a JZ140 are easily accessible thanks to the large bay doors that open wide and provide unobstructed access. Engine oil, hydraulic oil and fuel filters are centrally located for fast, straightforward servicing. The air filter is also easy to find, and has a double-element construction to simplify cleaning.

2 The cooling pack has increased in size, and the air condition condenser unit can be swung out for great access when cleaning all cooling packs.

A repositioned valve block is now far easier to access, despite more compact dimensions. All new hose routing from the valve block has been designed with reliability in mind.



1

	SERVICE INTERVALS
Engine oil and oil filter	Every 500 hours
Hydraulic oil	Every 5000 hours
Hydraulic oil filter	Every 1000 hours



1



2



Saving you time and money.

3 Because the EcoMAX engine doesn't need exhaust after treatment, it doesn't require costly heat-resistant lube oil, a DPF, or any DEF/ AdBlue.

Unlike most Tier 4i engines, JCB EcoMAX doesn't use a Diesel Particulate Filter (DPF) or SCR, saving you additional running costs.

We've eliminated the need for a visibowl style pre-cleaner on the JZ140 with our new optional scavenger filtration system. This uses suction from the cooling fan to remove heavier particles from the induction system.

The innovative recalibration option allows EcoMAX to run on lower grade fuels. This means your JZ140 can be resold across different territories, which improves residuals.

JCB's In-Cab Monitor checks engine oil levels, coolant, and system errors on start-up.



New and improved.

4 To make life even easier for you, we've revised the filter layout on the latest JCB JZ140, and reduced the number of fuel filters to two. Service access is now better than ever and a fuel shutoff tap as standard ensures downtime is reduced still further.

An all-new step layout has improved access to the upper structure.

The main valve block is located under the steps so you can inspect it very easily.

The JCB EcoMAX engine can also be reached through the counterweight, via a detachable panel, providing greater engine access.



LIVELINK, WORK SMARTER.

LIVELINK IS AN INNOVATIVE SOFTWARE SYSTEM THAT LETS YOU MANAGE JCB MACHINES REMOTELY – ONLINE, BY EMAIL OR BY MOBILE PHONE. ACCESS EVERYTHING FROM MACHINE ALERTS TO FUEL REPORTS AND HISTORY INFORMATION, WITH ALL DATA STORED AT A SECURE CENTRE.

Productivity and cost benefits

By providing information like idle time monitoring and machine fuel consumption, JCB LiveLink helps reduce your fuel usage, saving money and improving productivity. Machine location information can help improve efficiency and perhaps even reduce insurance costs.

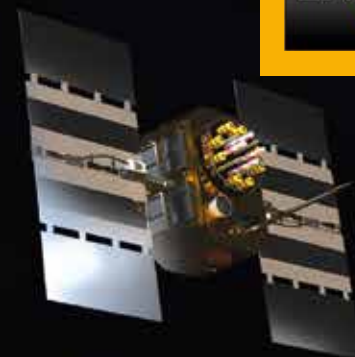

Maintenance benefits

Manage machine maintenance easily – accurate hours monitoring and service alerts improve maintenance planning, while real-time location data helps you manage your fleet. Critical machine alerts and maintenance history records are also available.



Security benefits

LiveLink's real-time geofencing alerts tell you when machines move out of predetermined zones, and real-time curfew alerts inform you of unauthorised usage. Further benefits include real-time location information, advanced ECU matching (pairs LiveLink with the immobiliser or ECU). Remote pin code management is also available.



VALUE ADDED.

JCB'S WORLDWIDE CUSTOMER SUPPORT IS FIRST CLASS. WHATEVER YOU NEED AND WHEREVER YOU ARE, WE'LL BE AVAILABLE QUICKLY AND EFFICIENTLY TO HELP MAKE SURE YOUR MACHINERY IS PERFORMING TO ITS FULL POTENTIAL.



1 Our Technical Support Service provides instant access to factory expertise, day or night, while our Finance and Insurance teams are always on hand to provide fast, flexible, competitive quotes.

2 The global network of JCB Parts Centres is another model of efficiency; with 16 regional bases, we can deliver around 95% of all parts anywhere in the world within 24 hours. Our genuine JCB parts are designed to work in perfect harmony with your machine for optimum performance and productivity.



3 JCB Assetcare offers comprehensive extended warranties and service agreements, as well as service-only or repair and maintenance contracts. Irrespective of what you opt for, our maintenance teams around the world charge competitive labour rates, and offer non-obligation quotations as well as fast, efficient insurance repair work.

Note: JCB LIVELINK and JCB ASSETCARE may not be available in your region, so please check with your local dealer.

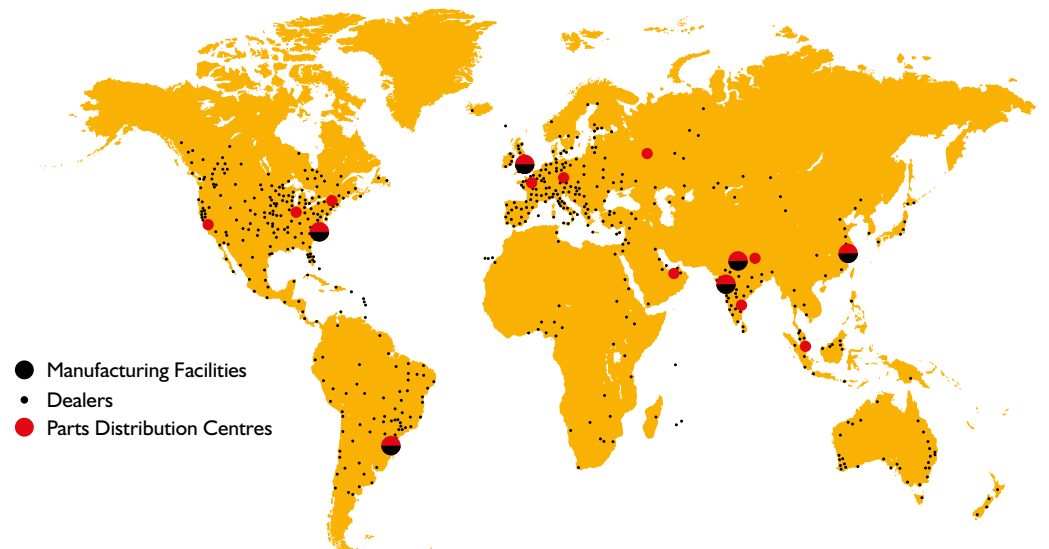
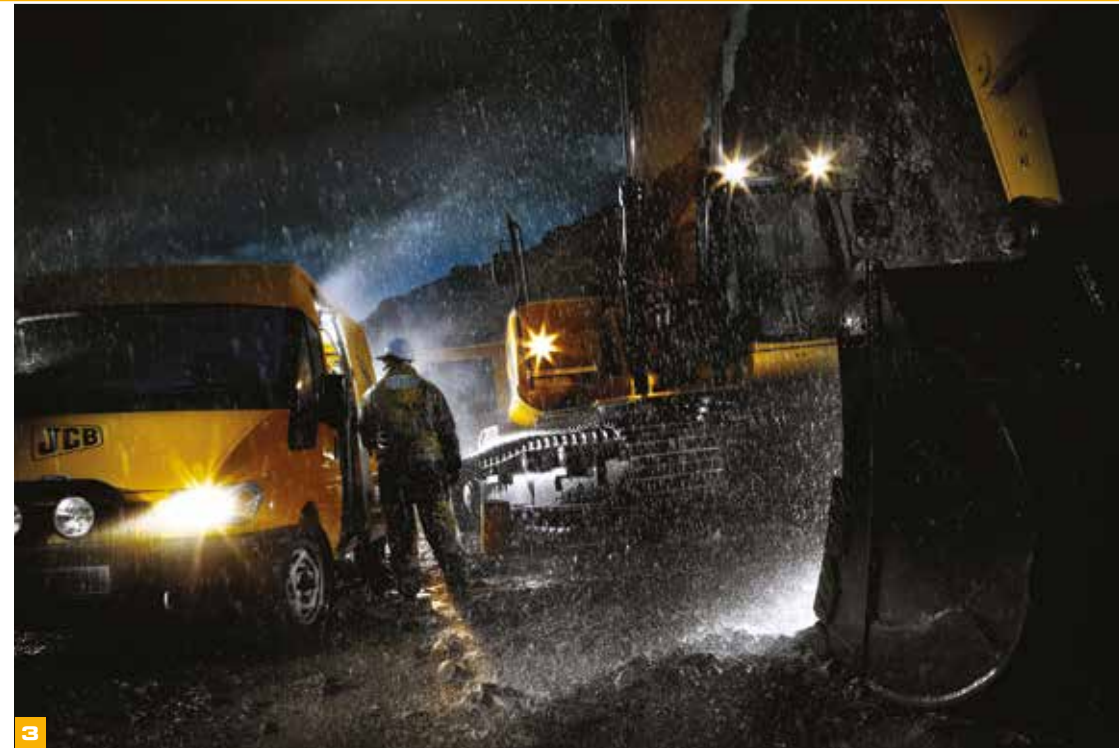

STATIC DIMENSIONS

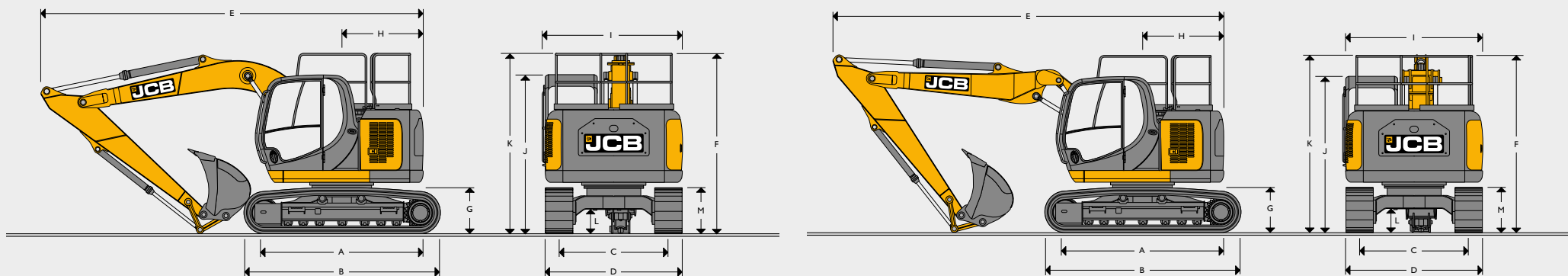

STATIC DIMENSIONS

Dimensions in mm		Monoboomb							T.A.B.								
		LC			HD				LC			HD					
A	Track length on ground	2865															
B	Undercarriage overall length	3590															
C	Track gauge	1990															
D	Width over tracks (500mm trackshoes)	2490															
D	Width over tracks (600mm trackshoes)	2590															
D	Width over tracks (700mm trackshoes)	2690															
D	Width over tracks (800mm trackshoes)	-															
D	Width over tracks (850mm trackshoes)	2840															
D	Width over tracks (900mm trackshoes)	-															
Boom options		Monoboomb 4.7m							T.A.B. 5.0m								
Dipper lengths		2.1m	2.5m	2.7m	3.0m	2.1m	2.5m	2.7m	3.0m	2.1m	2.5m	2.7m	3.0m	2.1m	2.5m	2.7m	3.0m
E	Transport length	7306	7331	7275	7284	7306	7331	7275	7284	7626	7591	7522	7440	7626	7591	7522	7440
F	Transport height	3227	3227	3300	3318	3337	3337	3410	3428	3227	3227	3227	3233	3337	3337	3337	3343
G	Counterweight clearance	916							1026								
H	Tailswing radius	1485							1485								
I	Width of superstructure	2500							2500								
J	Height over cab	2842							2952								
K	Height over grab rail	3227							3337								
L	Ground clearance	434							440								
M	Track height	820							832								

ENGINE	
Model	JCB EcoMAX 444 TCA 81 EU Stage IIIB, EPA Tier 4 interim compliant.
Type	Water cooled, 4-stroke, 4-cylinder in-line, common rail direct injection, turbocharged variable geometry intercooled diesel.
Rated power (net)	81 kW (109hp) at 2050rpm.
Piston displacement	4.4 litres.
Air filtration	Dry element with secondary safety element and in-cab warning indicator.
Starting system	24 volt.
Batteries	2 x 12 volt.
Alternator	24 volt 55 ampere

SLEW SYSTEM	
Slew motor	Axial piston type.
Slew brake	Hydraulic braking plus automatic spring applied disc type parking brake.
Slew torque	36.1 kNm
Slew speed	13.1 rpm.
Slew gear	Large diameter, internally toothed fully sealed grease bath lubricated.

TRACK DRIVE		
Type	Fully hydrostatic, three speed with autoshift.	
Travel motors	Variable swash axial piston type, fully guarded within undercarriage frame.	
Final drive	Planetary reduction, bolt-on sprockets.	
Service brake	Hydraulic counter balance valve.	
Park brake	Disc type, spring applied, automatic hydraulic release.	
Gradability	70% (35 deg) continuous.	
Travel speed	LC	HD
	High - 5.12 km/h	High - 4.28 km/h
	Mid - 3.00 km/h	Mid - 2.47 km/h
Tractive effort	Low - 1.83 km/h	Low - 1.51 km/h
	120.5 kNm	145.9 kNm

SERVICE CAPACITIES	
	Litres
Fuel tank	203
Engine coolant	23.6
Engine oil	14
Swing reduction gear	2.2
Track reduction gear (each side)	3.5
Hydraulic system	160
Hydraulic tank	67

UNDERCARRIAGE						
Carriage options	LC - Long Carriage, HD - Heavy Duty Carriage.					
Construction	Fully welded 'X' Frame type and sloping sidemembers with dirt relief holes under top rollers.					
Recovery point	Front and rear.					
Track shoes	500mm	600mm	700mm	800mm	850mm	900mm
LC	● X	●	●		●	
HD		●	●	●		●
Upper & lower rollers	Heat treated, sealed and lubricated.					
Track adjustment	Grease cylinder type.					
Track idler	Sealed and lubricated, with spring cushioned recoil.					
Track type	Sealed and lubricated.					
Rollers and shoes (each side)	LC			HD		
No. of track guides (optional)	2			2		
No. of lower rollers	7			7		
No. of upper rollers	2			2		
No. of track shoes	44			43		

● = Triple grouser, X = Geogrip.

HYDRAULIC SYSTEM

Open centered, negative control hydraulic system with twin variable flow piston pumps providing flow-on-demand.

Pumps

Main pumps	2 variable displacement axial piston type.
Maximum flow	2 x 124 l/min.
Servo pump	Gear type.
Maximum flow	20.5 l/min.

Control valve

A combined four and five spool control valve with auxiliary service spool as standard.

Relief valve settings

Boom/Arm/Bucket	314 bar.
With power boost	343 bar.
Slew circuit	279 bar.
Travel circuit	343 bar.
Pilot control	40 bar.

Filtration

In tank	150 micron, suction strainer.
Main return line	10 micron, glass fibre element.
Pilot line	10 micron, paper element.
Hydraulic hammer return	10 micron, reinforced microform element.

WEIGHTS AND GROUND BEARING PRESSURES

Figures include 383kg bucket, operator, full fuel tank and 2.5m dipper.

		500mm shoes	600mm shoes	700mm shoes	800mm shoes	850mm shoes	900mm shoes
LC Monoboam							
Machine weight	kg	15084	15300	15515	-	15839	-
Ground bearing pressure	kg/cm ²	0.48	0.41	0.35	-	0.30	-
LC T.A.B.							
Machine weight	kg	15607	15823	16038	-	16361	-
Ground bearing pressure	kg/cm ²	0.50	0.42	0.37	-	0.31	-
HD Monoboam							
Machine weight	kg	-	16648	16884	17122	-	17357
Ground bearing pressure	kg/cm ²	-	0.42	0.36	0.32	-	0.29
HD T.A.B.							
Machine weight	kg	-	17170	17406	17644	-	17880
Ground bearing pressure	kg/cm ²	-	0.43	0.37	0.33	-	0.30
LC Mono Dozer							
Machine weight	kg	15856	16079	16304	-	-	-
Ground bearing pressure	kg/cm ²	0.51	0.43	0.37	-	-	-
LC T.A.B. Dozer							
Machine weight	kg	16378	16602	16826	-	-	-
Ground bearing pressure	kg/cm ²	0.52	0.44	0.38	-	-	-

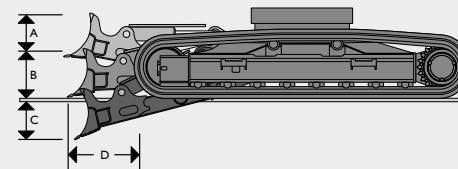
OPTIONAL BLADE

A	Blade height	mm	447
B	Blade lift above ground	mm	494
C	Blade cut below ground	mm	508
D	Blade forward of track	mm	412
	Dozer width – 500mm tracks	mm	2510
	Dozer width – 600mm tracks	mm	2610
	Dozer width – 700mm tracks	mm	2710
Additional machine weight with blade			
	500mm tracks	kg	636
	600mm tracks	kg	644
	700mm tracks	kg	653

Dozer not available with 800, 850 and 900mm track plates.

BUCKET AND ARM COMBINATION - MONOBOOM

Bucket options		GP Bucket						HD Bucket						Grade Bucket		
Bucket width	mm	600	700	800	1000	1200	1300	600	700	800	1000	1200	1300	1524	1836	1836
Bucket capacity	m ³	0.35	0.42	0.50	0.66	0.81	0.89	0.35	0.42	0.50	0.66	0.81	0.89	0.65	0.79	0.79
Bucket weight	kg	286	312	335	383	428	454	336	364	402	455	520	546	453	523	582

LC

2.10m Quickhitch (No Quickhitch)	□ (□)	□ (□)	□ (□)	□ (□)	□ (□)	□ (□)	■ (□)	□ (□)	□ (□)	□ (□)	□ (□)	□ (□)	■ (□)	□ (□)	□ (□)	□ (□)
2.50m Quickhitch (No Quickhitch)	□ (□)	□ (□)	□ (□)	□ (□)	□ (□)	■ (□)	■ (■)	□ (□)	□ (□)	□ (□)	□ (□)	■ (□)	■ (■)	□ (□)	■ (□)	■ (□)
2.70m Quickhitch (No Quickhitch)	□ (□)	□ (□)	□ (□)	□ (□)	□ (□)	■ (□)	■ (■)	□ (□)	□ (□)	□ (□)	□ (□)	■ (■)	● (■)	□ (□)	■ (□)	■ (■)
3.00m Quickhitch (No Quickhitch)	□ (□)	□ (□)	□ (□)	□ (□)	□ (□)	■ (■)	● (■)	□ (□)	□ (□)	□ (□)	□ (□)	● (■)	● (●)	□ (□)	● (■)	● (■)

LC + Dozer

2.10m Quickhitch (No Quickhitch)	□ (□)	□ (□)	□ (□)	□ (□)	□ (□)	□ (□)	□ (□)	□ (□)	□ (□)	□ (□)	□ (□)	□ (□)	□ (□)	□ (□)	□ (□)	□ (□)
2.50m Quickhitch (No Quickhitch)	□ (□)	□ (□)	□ (□)	□ (□)	□ (□)	□ (□)	□ (□)	□ (□)	□ (□)	□ (□)	□ (□)	□ (□)	■ (□)	□ (□)	□ (□)	■ (□)
2.70m Quickhitch (No Quickhitch)	□ (□)	□ (□)	□ (□)	□ (□)	□ (□)	□ (□)	■ (■)	□ (□)	□ (□)	□ (□)	□ (□)	■ (□)	■ (■)	□ (□)	■ (□)	■ (□)
3.00m Quickhitch (No Quickhitch)	□ (□)	□ (□)	□ (□)	□ (□)	□ (□)	■ (□)	■ (■)	□ (□)	□ (□)	□ (□)	□ (□)	■ (■)	● (■)	□ (□)	■ (■)	■ (■)

HD

2.10m Quickhitch (No Quickhitch)	□ (□)	□ (□)	□ (□)	□ (□)	□ (□)	□ (□)	□ (□)	□ (□)	□ (□)	□ (□)	□ (□)	□ (□)	□ (□)	□ (□)	□ (□)	□ (□)
2.50m Quickhitch (No Quickhitch)	□ (□)	□ (□)	□ (□)	□ (□)	□ (□)	□ (□)	□ (□)	□ (□)	□ (□)	□ (□)	□ (□)	□ (□)	■ (□)	□ (□)	□ (□)	□ (□)
2.70m Quickhitch (No Quickhitch)	□ (□)	□ (□)	□ (□)	□ (□)	□ (□)	□ (□)	□ (□)	□ (□)	□ (□)	□ (□)	□ (□)	□ (□)	□ (□)	□ (□)	□ (□)	□ (□)
3.00m Quickhitch (No Quickhitch)	□ (□)	□ (□)	□ (□)	□ (□)	□ (□)	□ (□)	■ (□)	□ (□)	□ (□)	□ (□)	□ (□)	■ (□)	■ (■)	□ (□)	□ (□)	■ (□)

BUCKET AND ARM COMBINATION - T.A.B.

Bucket options		GP Bucket						HD Bucket						Grade Bucket		
Bucket width	mm	600	700	800	1000	1200	1300	600	700	800	1000	1200	1300	1524	1836	1836
Bucket capacity	m ³	0.35	0.42	0.50	0.66	0.81	0.89	0.35	0.42	0.50	0.66	0.81	0.89	0.65	0.79	0.79
Bucket weight	kg	286	312	335	383	428	454	336	364	402	455	520	546	453	523	582

LC

2.10m Quickhitch (No Quickhitch)	□ (□)	□ (□)	□ (□)	□ (□)	□ (□)	■ (□)	■ (■)	□ (□)	□ (□)	□ (□)	□ (□)	■ (■)	● (■)	□ (□)	■ (■)	■ (■)
2.50m Quickhitch (No Quickhitch)	□ (□)	□ (□)	□ (□)	□ (□)	□ (□)	■ (■)	● (■)	□ (□)	□ (□)	□ (□)	■ (□)	● (■)	● (●)	■ (□)	● (■)	● (■)
2.70m Quickhitch (No Quickhitch)	□ (□)	□ (□)	□ (□)	■ (□)	● (■)	● (●)	● (●)	□ (□)	□ (□)	□ (□)	■ (□)	● (■)	● (●)	■ (□)	● (■)	● (●)
3.00m Quickhitch (No Quickhitch)	□ (□)	□ (□)	□ (□)	■ (□)	● (●)	● (●)	● (●)	□ (□)	□ (□)	□ (□)	■ (■)	● (●)	● (●)	■ (■)	● (●)	● (●)

LC + Dozer

2.10m Quickhitch (No Quickhitch)	□ (□)	□ (□)	□ (□)	□ (□)	□ (□)	■ (□)	■ (■)	□ (□)	□ (□)	□ (□)	□ (□)	■ (□)	■ (■)	□ (□)	■ (□)	■ (□)
2.50m Quickhitch (No Quickhitch)	□ (□)	□ (□)	□ (□)	□ (□)	□ (□)	■ (□)	● (■)	□ (□)	□ (□)	□ (□)	□ (□)	■ (■)	● (■)	□ (□)	■ (■)	■ (■)
2.70m Quickhitch (No Quickhitch)	□ (□)	□ (□)	□ (□)	□ (□)	□ (□)	■ (■)	● (■)	□ (□)	□ (□)	□ (□)	■ (□)	● (■)	● (●)	□ (□)	● (■)	● (■)
3.00m Quickhitch (No Quickhitch)	□ (□)	□ (□)	□ (□)	■ (□)	● (■)	● (●)	● (●)	□ (□)	□ (□)	□ (□)	■ (□)	● (■)	● (●)	■ (□)	● (■)	● (●)

HD

2.10m Quickhitch (No Quickhitch)	□ (□)	□ (□)	□ (□)	□ (□)	□ (□)	□ (□)	□ (□)	□ (□)	□ (□)	□ (□)	□ (□)	□ (□)	□ (□)	□ (□)	□ (□)	□ (□)
2.50m Quickhitch (No Quickhitch)	□ (□)	□ (□)	□ (□)	□ (□)	□ (□)	□ (□)	□ (□)	□ (□)	□ (□)	□ (□)	□ (□)	□ (□)	□ (□)	□ (□)	□ (□)	□ (□)
2.70m Quickhitch (No Quickhitch)	□ (□)	□ (□)	□ (□)	□ (□)	□ (□)	□ (□)	□ (□)	□ (□)	□ (□)	□ (□)	□ (□)	□ (□)	■ (□)	□ (□)	□ (□)	□ (□)
3.00m Quickhitch (No Quickhitch)	□ (□)	□ (□)	□ (□)	□ (□)	□ (□)	□ (□)	■ (□)	□ (□)	□ (□)	□ (□)	□ (□)	■ (□)	■ (■)	□ (□)	■ (□)	■ (□)

- = Material weight up to 1200kg/m³.
- = Material weight up to 1600kg/m³.
- = Material weight up to 2000kg/m³.

These recommendations are given as a guide based on typical operating conditions.
Please contact your distributor for the correct selection of buckets and attachments to suit the application.

WORKING RANGE - LC MONOBOOM 4.7M

Dipper length:		2.1m	2.5m	2.7m	3.0m
A	Maximum digging reach	mm 7961	8331	8465	8787
B	Maximum digging reach (on ground)	mm 7810	8187	8324	8651
C	Maximum digging depth	mm 5154	5557	5762	6055
D	Maximum digging height	mm 8886	9160	9275	9469
E	Maximum dumping height	mm 6418	6692	6807	7015
F	Maximum vertical wall cut depth	mm 4590	4986	5073	5488
G	Minimum swing radius	mm 2117	2175	2468	2535
	Bucket rotation	deg 182	182	182	182
	Maximum dipper tearout	kNm 74.7	66.3	64.8	60.1
	Maximum bucket tearout	kNm 92	92	92	92

WORKING RANGE - HD MONOBOOM 4.7M

Dipper length:		2.1m	2.5m	2.7m	3.0m
A	Maximum digging reach	mm 7961	8331	8465	8787
B	Maximum digging reach (on ground)	mm 7810	8187	8324	8651
C	Maximum digging depth	mm 5044	5447	5652	5945
D	Maximum digging height	mm 8996	9270	9385	9579
E	Maximum dumping height	mm 6528	6802	6917	7125
F	Maximum vertical wall cut depth	mm 4480	4876	4963	5378
G	Minimum swing radius	mm 2117	2175	2468	2535
	Bucket rotation	deg 182	182	182	182
	Maximum dipper tearout	kNm 74.7	66.3	64.8	60.1
	Maximum bucket tearout	kNm 92	92	92	92

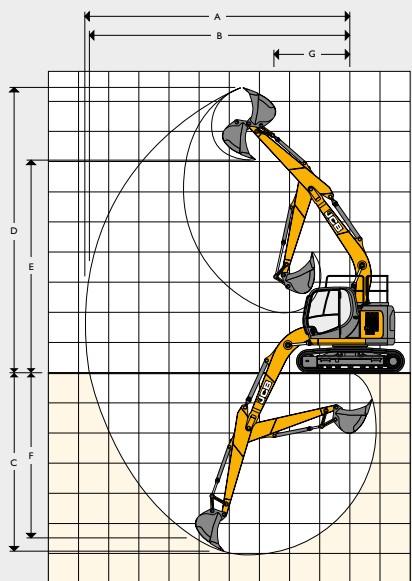









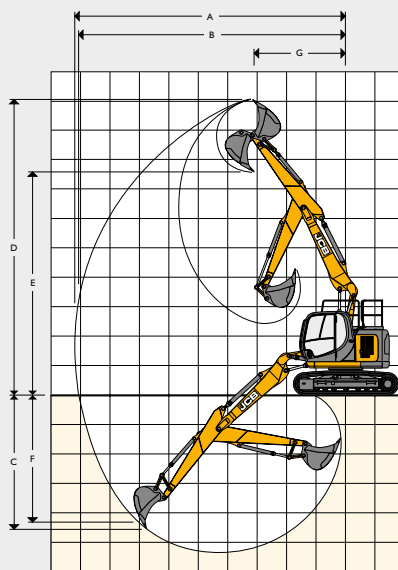





WORKING RANGE - LC T.A.B. 5.0M















Dipper length:		2.1m	2.5m	2.7m	3.0m
A	Maximum digging reach	mm 8356	8742	8884	9217
B	Maximum digging reach (on ground)	mm 8212	8608	8754	9090
C	Maximum digging depth	mm 4479	4883	5183	5382
D	Maximum digging height	mm 9355	9654	9733	10030
E	Maximum dumping height	mm 6887	7186	7289	7562
F	Maximum vertical wall cut depth	mm 3559	3909	4016	4336
G	Minimum swing radius	mm 2576	2691	3090	3109
	Bucket rotation	deg 182	182	182	182
	Maximum dipper tearout	kNm 74.7	66.3	64.8	60.1
	Maximum bucket tearout	kNm 92	92	92	92















WORKING RANGE - HD T.A.B. 5.0M

Dipper length:		2.1m	2.5m	2.7m	3.0m
A	Maximum digging reach	mm 8356	8742	8884	9217
B	Maximum digging reach (on ground)	mm 8212	8608	8754	9090
C	Maximum digging depth	mm 4369	4773	5073	5272
D	Maximum digging height	mm 9465	9764	9843	10140
E	Maximum dumping height	mm 6997	7296	7399	7672
F	Maximum vertical wall cut depth	mm 3449	3799	3906	4226
G	Minimum swing radius	mm 2576	2691	3090	3109
	Bucket rotation	deg 182	182	182	182
	Maximum dipper tearout	kNm 74.7	66.3	64.8	60.1
	Maximum bucket tearout	kNm 92	92	92	92



LIFT CAPACITIES – DIPPER LENGTH: 2.1M, 4.7M MONOBOOM, TRACKSHOES: 500MM, NO BUCKET															JZ140 LC MONO
Reach	2m		3m		4m		5m		6m		7m		Capacity at Max Reach		
															mm
Load Point Ht.	kg	kg	kg	kg	kg	kg	kg	kg	kg	kg	kg	kg	kg	kg	mm
6.0m					3980*	3980*	2950*	2950*					2940*	2940*	5001
5.0m					4150*	4150*	4110*	3110					2740*	2450	5750
4.0m	7200*	7200*	5510*	5510*	4760*	4330	4370*	3050	3450	2270			2660*	2110	6251
3.0m			7450*	6410	5660*	4120	4530	2940	3400	2220			2660*	1920	6562
2.0m					6240	3900	4400	2830	3340	2160			2730*	1820	6709
1.0m					6040	3720	4290	2720	3280	2100			2780	1790	6704
0m			6380*	5560	5920	3620	4210	2650	3230	2060			2850	1830	6546
- 1.0m	4820*	4820*	9430*	5550	5880	3580	4170	2620	3210	2050			3060	1950	6224
- 2.0m	8380*	8380*	9660*	5600	5890	3590	4180	2620					3470	2210	5709
- 3.0m	11270*	11270*	8500*	5700	5970	3650							4340	2740	4940





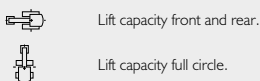









LIFT CAPACITIES – DIPPER LENGTH: 2.1M, 4.7M MONOBOOM, TRACKSHOES: 500MM, NO BUCKET, DOZER															JZ140 LC MONO
Reach	2m		3m		4m		5m		6m		7m		Capacity at Max Reach		
															mm
Load Point Ht.	kg	kg	kg	kg	kg	kg	kg	kg	kg	kg	kg	kg	kg	kg	mm
6.0m					3980*	3980*	2950*	2950*					2940*	2940*	5001
5.0m					4150*	4150*	4110*	3270					2740*	2580	5750
4.0m	7200*	7200*	5510*	5510*	4760*	4540	4370*	3210	3650	2390			2660*	2230	6251
3.0m			7450*	6730	5660*	4330	4790	3100	3610	2350			2660*	2030	6562
2.0m					6600	4110	4660	2980	3540	2290			2730*	1930	6709
1.0m					6400	3930	4550	2880	3480	2230			2880*	1900	6704
0m			6380*	5880	6280	3830	4470	2810	3430	2190			3030	1940	6546
- 1.0m	4820*	4820*	9430*	5870	6240	3790	4430	2770	3410	2170			3250	2070	6224
- 2.0m	8380*	8380*	9660*	5910	6250	3800	4430	2780					3680	2340	5709
- 3.0m	11270*	11270*	8500*	6020	6320	3860							4600	2900	4940

LIFT CAPACITIES – DIPPER LENGTH: 2.1M, 4.7M MONOBOOM, TRACKSHOES: 600MM, NO BUCKET															JZ140 HD MONO
Reach	2m		3m		4m		5m		6m		7m		Capacity at Max Reach		
															mm
Load Point Ht.	kg	kg	kg	kg	kg	kg	kg	kg	kg	kg	kg	kg	kg	kg	mm
6.0m					3980*	3980*	2950*	2950*					2940*	2940*	5001
5.0m					4150*	4150*	4110*	3910					2740*	2740*	5750
4.0m	7200*	7200*	5510*	5510*	4760*	4760*	4370*	3840	4070*	2880			2660*	2660*	6251
3.0m			7450*	7450*	5660*	5240	4830*	3740	4040	2830			2660*	2460	6562
2.0m					6630*	5010	5250	3610	3970	2770			2730*	2340	6709
1.0m					7310	4820	5140	3510	3910	2710			2880*	2310	6704
0m			6380*	6380*	7190	4720	5050	3430	3860	2670			3130*	2370	6546
- 1.0m	4820*	4820*	9430*	7380	7140	4680	5010	3400	3850	2650			3530*	2530	6224
- 2.0m	8380*	8380*	9660*	7430	7150	4690	5020	3400					4150	2860	5709
- 3.0m	11270*	11270*	8500*	7540	6590*	4760							4980*	3540	4940

















- Notes:
1. For lifting capacity including bucket, subtract total weight of bucket or bucket and quickhitch from above values.
 2. Lifting capacities are based on ISO 10567, that is: 75% of minimum tipping load or 87% of hydraulic lift capacity, whichever is the less. Lifting capacities marked* are based on hydraulic capacity.
 3. Lift capacities assume that the machine is on firm, level ground.
 4. Lift capacities may be limited by local regulations. Please refer to your dealer.

LIFT CAPACITIES – DIPPER LENGTH: 2.5M, 4.7M MONOBOOM, TRACKSHOES: 500MM, NO BUCKET **JZ140 LC MONO**

Reach	2m		3m		4m		5m		6m		7m		Capacity at Max Reach			
																mm
Load Point Ht.	kg	kg	kg	kg	kg	kg	kg	kg	kg	kg	kg	kg	kg	kg	kg	mm
6.0m					3450*	3450*	3660*	3180						2360*	2360*	5490
5.0m					3670*	3670*	3720*	3160	2970*	2320				2220*	2190	6179
4.0m			4720*	4720*	4280*	4280*	4030*	3090	3490	2300				2160*	1920	6648
3.0m			6560*	6560*	5190*	4190	4520*	2980	3430	2240				2160*	1760	6941
2.0m			8610*	6070	6210*	3950	4430	2850	3350	2170	3640	1700		2220*	1670	7080
1.0m			6750*	5710	6080	3750	4300	2730	3280	2100	2600	1670		2330*	1640	7076
0m			7090*	5550	5930	3620	4210	2650	3220	2050				2530*	1670	6926
- 1.0m	4840*	4840*	9110*	5510	5860	3560	4150	2600	3190	2020				2780	1770	6623
- 2.0m	7500*	7500*	9770	5530	5850	3550	4140	2590	3190	2030				3100	1970	6141
- 3.0m	10940*	10940*	9090*	5600	5890	3590	4180	2620						3720	2360	5435

LIFT CAPACITIES – DIPPER LENGTH: 2.5M, 4.7M MONOBOOM, TRACKSHOES: 500MM, NO BUCKET, DOZER **JZ140 LC MONO**







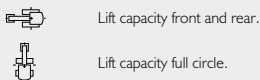







Reach	2m		3m		4m		5m		6m		7m		Capacity at Max Reach			
																mm
Load Point Ht.	kg	kg	kg	kg	kg	kg	kg	kg	kg	kg	kg	kg	kg	kg	kg	mm
6.0m					3450*	3450*	3660*	3330						2360*	2360*	5490
5.0m					3670*	3670*	3720*	3320	2970*	2440				2220*	2220*	6179
4.0m			4720*	4720*	4280*	4280*	4030*	3250	3690	2420				2160*	2030	6648
3.0m			6560*	6560*	5190*	4400	4520*	3140	2630	2370				2160*	1860	6941
2.0m			8610*	6390	6210*	4160	4690	3010	3550	2300	2750*	1810		2220*	1770	7080
1.0m			6750*	6030	6440	3960	4560	2890	3480	2230	2770	1770		2330*	1750	7076
0m			7090*	5870	6290	3830	4460	2800	3420	2180				2530*	1780	6926
- 1.0m	4840*	4840*	9110*	5820	6210	3770	4410	2750	3390	2150				2820*	1880	6623
- 2.0m	7500*	7500*	10020*	5840	6200	3760	4400	2740	3390	2150				3290	2090	6141
- 3.0m	10940*	10940*	9090*	5920	6250	3800	4440	2780						3950	2500	5435















LIFT CAPACITIES – DIPPER LENGTH: 2.5M, 4.7M MONOBOOM, TRACKSHOES: 600MM, NO BUCKET **JZ140 HD MONO**















Reach	2m		3m		4m		5m		6m		7m		Capacity at Max Reach			
																mm
Load Point Ht.	kg	kg	kg	kg	kg	kg	kg	kg	kg	kg	kg	kg	kg	kg	kg	mm
6.0m					3450*	3450*	3660*	3660*						2360*	2360*	5490
5.0m					3670*	3670*	3720*	3720*	2970*	2930				2220*	2220*	6179
4.0m			4720*	4720*	4280*	4280*	4030*	3890	3910*	2910				2160*	2160*	6648
3.0m			6560*	6560*	5190*	5190*	4520*	3770	4070	2850				2160*	2160*	6941
2.0m			8610*	7940	6210*	5070	5090*	3640	3990	2780	2750*	2200		2220*	2160	7080
1.0m			6750*	6750*	7080*	4860	5150	3520	3910	2710	2890*	2160		2330*	2130	7076
0m			7090*	7090*	7200	4720	5050	3430	3580	2660				2530*	2170	6926
- 1.0m	4840*	4840*	9110*	7340	7120	4650	5000	3380	3820	2620				2820*	2300	6623
- 2.0m	7500*	7500*	10020*	7360	7110	4640	4980	3370	3830	2630				3320*	2560	6141
- 3.0m	10940*	10940*	9090*	7440	6990*	4690	5030	3410						4250*	3050	5435



- Notes:**
1. For lifting capacity including bucket, subtract total weight of bucket or bucket and quickhitch from above values.
 2. Lifting capacities are based on ISO 10567, that is: 75% of minimum tipping load or 87% of hydraulic lift capacity, whichever is the less. Lifting capacities marked* are based on hydraulic capacity.
 3. Lift capacities assume that the machine is on firm, level ground.
 4. Lift capacities may be limited by local regulations. Please refer to your dealer.

LIFT CAPACITIES – DIPPER LENGTH: 2.7M, 4.7M MONOBOOM, TRACKSHOES: 500MM, NO BUCKET															JZ140 LC MONO
Reach	2m		3m		4m		5m		6m		7m		Capacity at Max Reach		
															mm
Load Point Ht.	kg	kg	kg	kg	kg	kg	kg	kg	kg	kg	kg	kg	kg	kg	mm
6.0m					3200*	3200*	3480*	3210					2470*	2470*	5720
5.0m					3430*	3430*	3530*	3190	3430*	2340			2340*	2080	6384
4.0m					4030*	4030*	3840*	3110	3500	2310			2290*	1830	6839
3.0m			6110*	6110*	4940*	4220	4350*	2990	3440	2250	2680	1740	2290*	1680	7124
2.0m			8180*	6140	5980*	3980	4440	2860	3360	2170	2640	1700	2350*	1600	7260
1.0m			7560*	5730	6090	3760	4310	2730	3270	2100	2600	1660	2460	1570	7255
0m			7290*	5530	5920	3610	4200	2640	3210	2040	2570	1630	2510	1600	7110
- 1.0m	4700*	4700*	8960*	5460	5830	3530	4130	2580	3170	2000			2650	1680	6814
- 2.0m	7130*	7130*	9710	5470	5810	3510	4110	2560	3170	2000			2930	1860	6348
- 3.0m	10290*	10290*	9310*	5540	5850	3550	4140	2590					3480	2200	5667

LIFT CAPACITIES – DIPPER LENGTH: 2.7M, 4.7M MONOBOOM, TRACKSHOES: 500MM, NO BUCKET, DOZER															JZ140 LC MONO
Reach	2m		3m		4m		5m		6m		7m		Capacity at Max Reach		
															mm
Load Point Ht.	kg	kg	kg	kg	kg	kg	kg	kg	kg	kg	kg	kg	kg	kg	mm
6.0m					3200*	3200*	3480*	3370					2470*	2470*	5720
5.0m					3430*	3430*	3530*	3350	3430*	2470			2340*	2200	6384
4.0m					4030*	4030*	3840*	3270	3700	2440			2290*	1940	6839
3.0m			6110*	6110*	4940*	4440	4350*	3150	3640	2370	2840	1840	2290*	1790	7124
2.0m			8180*	6460	5980*	4190	4700	3020	3560	2300	2810	1810	2350*	1700	7260
1.0m			7560*	6050	6450	3970	4560	2890	3480	2230	2760	1770	2470*	1670	7255
0m			7290*	5850	6280	3820	4460	2790	3410	2170	2730	1740	2660*	1700	7110
- 1.0m	4700*	4700*	8960*	5780	6190	3740	4390	2740	3370	2130			2820	1790	6814
- 2.0m	7130*	7130*	10130*	5790	6170	3720	4370	2720	3370	2120			3120	1980	6348
- 3.0m	10290*	10290*	9310*	5860	6210	3760	4400	2740					3690	2340	5667



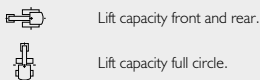











LIFT CAPACITIES – DIPPER LENGTH: 2.7M, 4.7M MONOBOOM, TRACKSHOES: 600MM, NO BUCKET															JZ140 HD MONO
Reach	2m		3m		4m		5m		6m		7m		Capacity at Max Reach		
															mm
Load Point Ht.	kg	kg	kg	kg	kg	kg	kg	kg	kg	kg	kg	kg	kg	kg	mm
6.0m					3200*	3200*	3480*	3480*					2470*	2470*	5720
5.0m					3430*	3430*	3530*	3530*	3430*	2950			2340*	2340*	6384
4.0m					4030*	4030*	3840*	3840*	3750*	2920			2290*	2290*	6839
3.0m			6110*	6110*	4940*	4940*	4350*	3790	4020*	2860	2880*	2230	2290*	2170	7124
2.0m			8180*	8010	5980*	5090	4930*	3650	3990	2780	3150	2200	2350*	2070	7260
1.0m			7560*	7560*	6900*	4870	5160	3520	3910	2710	3100	2160	2470*	2040	7255
0m			7290*	7290*	7190	4710	5050	3420	3840	2650	3070	2130	2660*	2080	7110
- 1.0m	4700*	4700*	8960*	7290	7100	4630	4980	3360	3800	2610			2970*	2200	6814
- 2.0m	7130*	7130*	10130*	7300	7070	4610	4960	3340	3800	2600			3450*	2420	6348
- 3.0m	10290*	10290*	9310*	7370	7110	4640	4990	3370					4170	2860	5667

















Notes:

1. For lifting capacity including bucket, subtract total weight of bucket or bucket and quickhitch from above values.
2. Lifting capacities are based on ISO 10567, that is: 75% of minimum tipping load or 87% of hydraulic lift capacity, whichever is the less. Lifting capacities marked* are based on hydraulic capacity.
3. Lift capacities assume that the machine is on firm, level ground.
4. Lift capacities may be limited by local regulations. Please refer to your dealer.



LIFT CAPACITIES – DIPPER LENGTH: 3.0M, 4.7M MONOBOOM, TRACKSHOES: 500MM, NO BUCKET **JZ140 LC MONO**

Reach	2m		3m		4m		5m		6m		7m		Capacity at Max Reach		
															
Load Point Ht.	kg	kg	kg	kg	kg	kg	kg	kg	kg	kg	kg	kg	kg	kg	mm
6.0m							3150	3150	2380*	2350			2160*	2160*	6070
5.0m							3230	3220	3360*	2370			2050*	1930	6699
4.0m					3650*	3650*	3570	3140	3520*	2330	2490*	1770	2010*	1710	7133
3.0m			5440*	5440*	4560*	4280	4090	3020	3450	2260	2690	1750	2020*	1580	7407
2.0m			7540*	6270	5630*	4020	4470	2880	3360	2180	2640	1700	2070*	1500	7538
1.0m			9270*	5800	6130	3790	4320	2740	3280	2100	2590	1660	2170*	1470	7533
0m			7810*	5540	5930	3620	4200	2630	3200	2030	2550	1620	2330*	1490	7393
- 1.0m	4620*	4620*	8850*	5440	5820	3520	4120	2560	3150	1980	2530	1600	2480	1570	7110
- 2.0m	6660*	6660*	9650	5420	5780	3480	4080	2530	3140	1970			2710	1710	6664
- 3.0m	9310*	9310*	9610*	5470	5800	3500	4100	2540	3170	2000			3160	1990	6020

LIFT CAPACITIES – DIPPER LENGTH: 3.0M, 4.7M MONOBOOM, TRACKSHOES: 500MM, NO BUCKET, DOZER **JZ140 LC MONO**







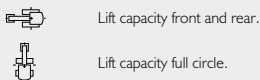







Reach	2m		3m		4m		5m		6m		7m		Capacity at Max Reach		
															
Load Point Ht.	kg	kg	kg	kg	kg	kg	kg	kg	kg	kg	kg	kg	kg	kg	mm
6.0m							3150*	3150*	2380*	2380*			2160*	2160*	6070
5.0m							3230*	3230*	3360*	2490			2050*	2040	6699
4.0m					3650*	3650*	3570*	3300	3520*	2450	2490*	1880	2010*	1810	7133
3.0m			5440*	5440*	4560*	4490	4090*	3180	3650	2390	2850	1850	2020*	1670	7407
2.0m			7540*	6590	5630*	4230	4700*	3040	3570	2310	2810	1810	2070*	1600	7538
1.0m			9270*	6120	6490	4000	4580	2900	3480	2220	2760	1760	2170*	1570	7533
0m			7810*	5860	6290	3830	4460	2790	3400	2160	2720	1720	2330*	1590	7393
- 1.0m	4620*	4620*	8850*	5760	6180	3730	4380	2720	3350	2110	2700	1700	2570*	1670	7110
- 2.0m	6660*	6660*	10240	5740	6140	3690	4340	2690	3340	2090			2890	1820	6664
- 3.0m	9310*	9310*	9610*	5790	6160	3710	4360	2700	3370	2130			3360	2120	6020















LIFT CAPACITIES – DIPPER LENGTH: 3.0M, 4.7M MONOBOOM, TRACKSHOES: 600MM, NO BUCKET **JZ140 HD MONO**















Reach	2m		3m		4m		5m		6m		7m		Capacity at Max Reach		
															
Load Point Ht.	kg	kg	kg	kg	kg	kg	kg	kg	kg	kg	kg	kg	kg	kg	mm
6.0m							3150*	3150*	2380*	2380*			2160*	2160*	6070
5.0m							3230*	3230*	3360*	2980			2050*	2050*	6699
4.0m					3650*	3650*	3570*	3570*	3520*	2940	2490*	2270	2010*	2010*	7133
3.0m			5440*	5440*	4560*	4560*	4090*	3820	3810*	2870	3200	2240	2020*	2020*	7407
2.0m			7540*	7540*	5630*	5140	4700*	3670	4000	2790	3150*	2200	2070*	1950	7538
1.0m			9270*	7660	6610*	4900	5170	3530	3910	2710	3100*	2150	2170*	1920	7533
0m			7810*	7380	7200	4720	5050	3420	3840	2640	3060	2110	2330*	1950	7393
- 1.0m	4620*	4620*	8850*	7270	7080	4620	4960	3340	3790	2590	3040	2090	2570*	2050	7110
- 2.0m	6660*	6660*	10270*	7250	7040	4580	4930	3310	3770	2570			2970*	2240	6664
- 3.0m	9310*	9310*	9610*	7300	7060	4600	4940	3330	3800	2610			3650*	2590	6020



- Notes:
1. For lifting capacity including bucket, subtract total weight of bucket or bucket and quickhitch from above values.
 2. Lifting capacities are based on ISO 10567, that is: 75% of minimum tipping load or 87% of hydraulic lift capacity, whichever is the less. Lifting capacities marked* are based on hydraulic capacity.
 3. Lift capacities assume that the machine is on firm, level ground.
 4. Lift capacities may be limited by local regulations. Please refer to your dealer.







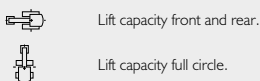







LIFT CAPACITIES – DIPPER LENGTH: 2.1M, 5.0M T.A.B., TRACKSHOES: 500MM, NO BUCKET															JZ140 LC T.A.B.
Reach	2m		3m		4m		5m		6m		7m		Capacity at Max Reach		
															mm
Load Point Ht.	kg	kg	kg	kg	kg	kg	kg	kg	kg	kg	kg	kg	kg	kg	mm
6.0m					3930*	3930*	3950*	3130					3030*	2590	5524
5.0m					4220*	4220*	3990*	3110	3340	2260			2800*	2110	6209
4.0m					5950*	5950*	4860*	4280	3310	2240			2690*	1840	6675
3.0m					5750*	4010	4310	2870	3240	2170			2530	1680	6967
2.0m					5860	3740	4150	2730	3150	2090	2480	1640	2420	1590	7106
1.0m					5640	3540	4020	2610	3080	2020	2450	1610	2400	1570	7101
0m					5530	3440	3930	2530	3020	1970			2450	1600	6953
- 1.0m			5950*	5330	5490	3410	3890	2490	3000	1940			2610	6650	1710
- 2.0m			9130*	5390	5520	3430	3900	2500	3030	1970			2930	1910	6171
- 3.0m					5600	3510	3980	2570					3670	2390	5299















LIFT CAPACITIES – DIPPER LENGTH: 2.1M, 5.0M T.A.B., TRACKSHOES: 500MM, NO BUCKET, DOZER															JZ140 LC T.A.B.
Reach	2m		3m		4m		5m		6m		7m		Capacity at Max Reach		
															mm
Load Point Ht.	kg	kg	kg	kg	kg	kg	kg	kg	kg	kg	kg	kg	kg	kg	mm
6.0m					3930*	3930*	3950*	3290					3030*	2730	5524
5.0m					4220*	4220*	3990*	3270	3680	2390			2800*	2230	6209
4.0m			5950*	5950*	4860*	4490	4310*	3170	3650	2360			2690*	1950	6675
3.0m					5750*	4220	4750	3030	3580	2290			2650*	1780	6967
2.0m					6470	3950	4590	2880	3490	2210	2760	1740	2670*	1700	7106
1.0m					6250	3750	4460	2760	3410	2140	2720	1710	2670	1670	7101
0m					6130	3650	4370	2680	3360	2090			2730	1710	6953
- 1.0m			5950*	5650	6100	3620	4330	2650	3340	2070			2910	1820	6650
- 2.0m			9130*	5710	6120	3640	4340	2660	3360	2100			3250	2030	6171
- 3.0m					6210	3720	4410	2720					4080	2530	5299















LIFT CAPACITIES – DIPPER LENGTH: 2.1M, 5.0M T.A.B., TRACKSHOES: 600MM, NO BUCKET															JZ140 HD T.A.B.
Reach	2m		3m		4m		5m		6m		7m		Capacity at Max Reach		
															mm
Load Point Ht.	kg	kg	kg	kg	kg	kg	kg	kg	kg	kg	kg	kg	kg	kg	mm
6.0m					3930*	3930*	3950*	3940					3030*	3030*	5524
5.0m					4220*	4220*	3990*	3920	3960*	2880			2800*	2690	6209
4.0m			5950*	5950*	4860*	4860*	4310*	3820	4020*	2850			2690*	2370	6675
3.0m					5750*	5140	4770*	3670	4020	2780			2650*	2180	6967
2.0m					6640*	4860	5190	3520	3930	2700	3110	2140	2670*	2080	7106
1.0m					7170	4650	5060	3400	3850	2630	3070	2110	2760*	2060	7101
0m					7050	4550	4970	3320	3800	2580			2900*	2110	6953
- 1.0m			5950*	5950*	7010	4520	4920	3280	3770	2560			3170*	2240	6650
- 2.0m			9130*	7240	7040	4540	4940	3290	3800	2580			3600*	2500	6171
- 3.0m					6410*	4620	5010	3360					4560*	3120	5299



- Notes:
1. For lifting capacity including bucket, subtract total weight of bucket or bucket and quickhitch from above values.
 2. Lifting capacities are based on ISO 10567, that is: 75% of minimum tipping load or 87% of hydraulic lift capacity, whichever is the less. Lifting capacities marked* are based on hydraulic capacity.
 3. Lift capacities assume that the machine is on firm, level ground.
 4. Lift capacities may be limited by local regulations. Please refer to your dealer.

LIFT CAPACITIES – DIPPER LENGTH: 2.5M, 5.0M T.A.B., TRACKSHOES: 500MM, NO BUCKET														JZ140 LC T.A.B.		
Reach	2m		3m		4m		5m		6m		7m		Capacity at Max Reach			
																
Load Point Ht.	kg	kg	kg	kg	kg	kg	kg	kg	kg	kg	kg	kg	kg	kg	kg	mm
6.0m					3490*	3490	3550*	3210	2530*	2280				2430*	2270	6014
5.0m					3800*	3800*	3660*	3170	3400	2310				2260*	1890	6649
4.0m			5080*	5080*	4440*	4380	4000*	3060	3350	2270	2570	1710		2180*	1670	7086
3.0m					5320*	4100	4360	2920	3270	2190	2540	1690		2160*	1530	7361
2.0m					5950	3810	4190	2760	3170	2100	2490	1650		2170*	1460	7493
1.0m					5690	3580	4040	2620	3080	2020	2450	1600		2210	1440	7488
0m					5530	3440	3930	2520	3010	1960	2410	1570		2250	1460	7347
- 1.0m			6010*	5260	5460	3380	3870	2470	2970	1920	2400	1560		2380	1550	7062
- 2.0m	5440*	5440*	9000*	5300	5460	3380	3860	2460	2980	1920				2620	1710	6613
- 3.0m			8640*	5400	5520	3440	3910	2500						3080	2010	5964





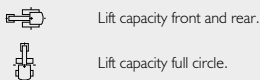









LIFT CAPACITIES – DIPPER LENGTH: 2.5M, 5.0M T.A.B., TRACKSHOES: 500MM, NO BUCKET, DOZER														JZ140 LC T.A.B.		
Reach	2m		3m		4m		5m		6m		7m		Capacity at Max Reach			
																
Load Point Ht.	kg	kg	kg	kg	kg	kg	kg	kg	kg	kg	kg	kg	kg	kg	kg	mm
6.0m					3490*	3490*	3550*	3370	2530*	2400				2430*	2390	6014
5.0m					3800*	3800*	3660*	3320	3620*	2440				2260*	2000	6649
4.0m			5080*	5080*	4440*	4440*	4000*	3220	3690	2390	2780*	1820		2180*	1770	7086
3.0m					5320*	4310	4490*	3070	3600	2320	2820	1800		2160*	1630	7361
2.0m					6260*	4020	4630	2920	3510	2230	2770	1750		2170*	1560	7493
1.0m					6300	3790	4480	2780	3420	2140	2720	1710		2240*	1540	7488
0m					6140	3650	4370	2680	3350	2080	2690	1670		2370*	1560	7347
- 1.0m			6010*	5580	6070	3590	4310	2630	3310	2050	2680	1670		2560*	1650	7062
- 2.0m	5440*	5440*	9000*	5620	6070	3590	4300	2620	3310	2050				2870*	1820	6613
- 3.0m			8640*	5720	6130	3650	4340	2660						3400*	2130	5964















LIFT CAPACITIES – DIPPER LENGTH: 2.5M, 5.0M T.A.B., TRACKSHOES: 600MM, NO BUCKET														JZ140 HD T.A.B.		
Reach	2m		3m		4m		5m		6m		7m		Capacity at Max Reach			
																
Load Point Ht.	kg	kg	kg	kg	kg	kg	kg	kg	kg	kg	kg	kg	kg	kg	kg	mm
6.0m					3490*	3490*	3550*	3550*	2530*	2530*				2430*	2430*	6014
5.0m					3800*	3800*	3660*	3660*	3620*	2940				2260*	2260*	6649
4.0m			5080*	5080*	4440*	4440*	4000*	3870	3760*	2890	2780*	2220		2180*	2160	7086
3.0m					5320*	5240	4490*	3720	4020*	2810	3170	2190		2160*	2000	7361
2.0m					6260*	4930	5020*	3560	3950	2720	3120	2150		2170*	1920	7493
1.0m					7010*	4690	5080	3420	3860	2630	3070	2100		2240*	1900	7488
0m					7060	4550	4970	3310	3790	2570	3030	2070		2370*	1930	7347
- 1.0m			6010*	6010*	6990	4490	4900	3260	3750	2530	3020	2060		2560*	2040	7062
- 2.0m	5440*	5440*	9000*	7140	6990	4490	4890	3250	3750	2530				2870*	2240	6613
- 3.0m			8640*	7250	6750*	4550	4940	3290						3400*	2630	5964

















Notes:

1. For lifting capacity including bucket, subtract total weight of bucket or bucket and quickhitch from above values.
2. Lifting capacities are based on ISO 10567, that is: 75% of minimum tipping load or 87% of hydraulic lift capacity, whichever is the less. Lifting capacities marked* are based on hydraulic capacity.
3. Lift capacities assume that the machine is on firm, level ground.
4. Lift capacities may be limited by local regulations. Please refer to your dealer.

LIFT CAPACITIES – DIPPER LENGTH: 2.7M, 5.0M T.A.B., TRACKSHOES: 500MM, NO BUCKET															JZ140 LC T.A.B.
Reach	2m		3m		4m		5m		6m		7m		Capacity at Max Reach		
															mm
Load Point Ht.	kg	kg	kg	kg	kg	kg	kg	kg	kg	kg	kg	kg	kg	kg	mm
6.0m							3370*	3240	3410*	2330			2540*	2130	6248
5.0m					3580*	3580*	3500*	3200	3240	2340			2390*	1800	6860
4.0m			4130*	4130*	4210*	4210*	3840*	3090	3370	2280	2590	1730	2300*	1590	7285
3.0m					5090*	4140	4340*	2940	3280	2200	2550	1700	2230	1470	7553
2.0m					5990	3840	4210	2770	3180	2110	2500	1650	2140	1400	7681
1.0m					5700	3590	4040	2620	3080	2020	2440	1600	2120	1380	7677
0m					5520	3430	3920	2510	3000	1950	2400	1560	2160	1400	7539
- 1.0m			5880*	5200	5440	3360	3850	2450	2960	1900	2380	1540	2270	1470	7262
- 2.0m	5140*	5140*	8580*	5240	5420	3340	3830	2430	2950	1900			2490	1610	6826
- 3.0m			8860*	5330	5470	3390	3870	2460	3000	1940			2890	1880	6199





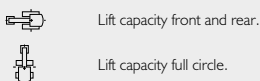









LIFT CAPACITIES – DIPPER LENGTH: 2.7M, 5.0M T.A.B., TRACKSHOES: 500MM, NO BUCKET, DOZER															JZ140 LC T.A.B.
Reach	2m		3m		4m		5m		6m		7m		Capacity at Max Reach		
															mm
Load Point Ht.	kg	kg	kg	kg	kg	kg	kg	kg	kg	kg	kg	kg	kg	kg	mm
6.0m							3370*	3370*	3410*	2450			2540*	2250	6248
5.0m					3580*	3580*	3500*	3350	3470*	2460			2390*	1900	6860
4.0m			4130*	4130*	4210*	4210*	3840*	3240	3630*	2410	2860	1840	2300*	1690	7285
3.0m					5090*	4350	4340*	3090	3620	2330	2820	1800	2280*	1560	7553
2.0m					6050*	4050	4640	2930	3510	2230	2770	1750	2310*	1490	7681
1.0m					6310	3800	4480	2780	3420	2140	2720	1700	2360	1470	7677
0m					6130	3640	4360	2670	3340	2070	3670	1660	2410	1490	7539
- 1.0m			5880*	5520	6050	3570	4290	2610	3290	2030	2660	1640	2530	1570	7262
- 2.0m	5140*	5140*	8580*	5550	6030	3560	4270	2590	3290	2020			2770	1720	6826
- 3.0m			8860*	5640	6080	3600	4300	2620	3340	2070			3210	2000	6199















LIFT CAPACITIES – DIPPER LENGTH: 2.7M, 5.0M T.A.B., TRACKSHOES: 600MM, NO BUCKET															JZ140 HD T.A.B.
Reach	2m		3m		4m		5m		6m		7m		Capacity at Max Reach		
															mm
Load Point Ht.	kg	kg	kg	kg	kg	kg	kg	kg	kg	kg	kg	kg	kg	kg	mm
6.0m							3370*	3370*	3410*	2950			2540*	2540*	6248
5.0m					3580*	3580*	3500*	3500*	3470*	2960			2390*	2310	6860
4.0m			4130*	4130*	4210*	4210*	3840*	3840*	3630*	2900	3210	2230	2300*	2070	7285
3.0m					5090*	5090*	4340*	3740	3900*	2820	3170	2200	2280*	1920	7553
2.0m					6050*	4970	4880*	3570	3960	2720	3120	2150	2310*	1840	7681
1.0m					6850*	4710	5080	3420	3860	2630	3060	2100	2370*	1820	7677
0m					7050	4540	4960	3300	3780	2560	3020	2060	2500*	1850	7539
- 1.0m			5880*	5880*	6960	4460	4890	3240	3730	2510	3000	2040	2700*	1950	7262
- 2.0m	5140*	5140*	8580*	7080	6950	4450	4870	3220	3730	2510			3020*	2130	6826
- 3.0m			8860*	7170	6870*	4500	4900	3250	3780	2550			3550*	2460	6199

















Notes:

1. For lifting capacity including bucket, subtract total weight of bucket or bucket and quickhitch from above values.
2. Lifting capacities are based on ISO 10567, that is: 75% of minimum tipping load or 87% of hydraulic lift capacity, whichever is the less. Lifting capacities marked* are based on hydraulic capacity.
3. Lift capacities assume that the machine is on firm, level ground.
4. Lift capacities may be limited by local regulations. Please refer to your dealer.

LIFT CAPACITIES – DIPPER LENGTH: 3.0M, 5.0M T.A.B., TRACKSHOES: 500MM, NO BUCKET															JZ140 LC T.A.B.	
Reach	2m		3m		4m		5m		6m		7m		Capacity at Max Reach			
															mm	
Load Point Ht.	kg	kg	kg	kg	kg	kg	kg	kg	kg	kg	kg	kg	kg	kg	mm	
6.0m					3930*	3930*	3950*	3130						3030*	2590	5524
5.0m					4220*	4220*	3990*	3110	3340	2260				2800*	2110	6209
4.0m			5950*	5950*	4860*	4280	4310*	3010	3310	2240				2690*	1840	6675
3.0m					5750*	4010	4310	2870	3240	2170				2530	1680	6967
2.0m					5860	3740	4150	2730	3150	2090	2480	1640		2420	1590	7106
1.0m					5640	3540	4020	2610	3080	2020	2450	1610		2400	1570	7101
0m					5530	3440	3930	2530	3020	1970				2450	1600	6953
- 1.0m			5950*	5330	5490	3410	3890	2490	3000	1940				2610	1710	6650
- 2.0m			9130*	5390	5520	3430	3900	2500	3030	1970				2930	1910	6171
- 3.0m					5600	3510	3980	2570						3670	2390	5299

LIFT CAPACITIES – DIPPER LENGTH: 3.0M, 5.0M T.A.B., TRACKSHOES: 500MM, NO BUCKET, DOZER															JZ140 LC T.A.B.	
Reach	2m		3m		4m		5m		6m		7m		Capacity at Max Reach			
															mm	
Load Point Ht.	kg	kg	kg	kg	kg	kg	kg	kg	kg	kg	kg	kg	kg	kg	mm	
6.0m							3100*	3100*	3240*	2500				2210*	2060	6599
5.0m							3250*	3250*	3250*	2490	2770*	1870		2090*	1760	7182
4.0m					3760*	3760*	3600*	3280	3430*	2430	2880	1860		2020*	1580	7588
3.0m					4750*	4430	4100*	3130	3640	2340	2840	1810		2010*	1460	7845
2.0m					5740*	4110	4670*	2950	3530	2240	2780	1750		2030*	1400	7969
1.0m					6360	3830	4500	2790	3420	2140	2710	1700		2080*	1380	7965
0m					6140	3650	4360	2670	3330	2060	2660	1650		2190*	1390	7833
- 1.0m			5870*	5490	6030	3550	4270	2590	3280	2010	2630	1260		2350*	1460	7566
- 2.0m	4850*	4850*	8080*	5490	6000	3520	4240	2560	3260	1990	2640	1620		2570	1590	7149
- 3.0m	7270*	7270*	9160*	5560	6030	3550	4260	2580	3280	2010				2930	1820	6553

LIFT CAPACITIES – DIPPER LENGTH: 3.0M, 5.0M T.A.B., TRACKSHOES: 600MM, NO BUCKET															JZ140 HD T.A.B.	
Reach	2m		3m		4m		5m		6m		7m		Capacity at Max Reach			
															mm	
Load Point Ht.	kg	kg	kg	kg	kg	kg	kg	kg	kg	kg	kg	kg	kg	kg	mm	
6.0m							3100*	3100*	3240*	3000				2210*	2210*	6599
5.0m							3250*	3250*	3250*	2990	2770*	2270		2090*	2090*	7182
4.0m					3760*	3760*	3600*	3600*	3430*	2930	3240	2260		2020*	1930	7588
3.0m					4750*	4750*	4100*	3780	3720*	2840	3190	2210		2010*	1800	7845
2.0m					5740*	5030	4670*	3600	3970	2730	3130	2150		2030*	1730	7969
1.0m					6600*	4740	5100	3430	3860	2630	3060	2090		2080*	1710	7965
0m					7060	4550	4960	3300	3780	2550	3010	2040		2190*	1740	7833
- 1.0m			5870*	5870*	6940	4450	4870	3220	3720	2500	2980	2010		2350*	1820	7566
- 2.0m	4850*	4850*	8080*	7010	6910	4410	4840	3190	3700	2480	2980	2020		2610*	1970	7149
- 3.0m	7270*	7270*	9160*	7090	6940	4440	4850	3210	3720	2500				3030*	2250	6553

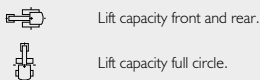

Notes:

1. For lifting capacity including bucket, subtract total weight of bucket or bucket and quickhitch from above values.
2. Lifting capacities are based on ISO 10567, that is: 75% of minimum tipping load or 87% of hydraulic lift capacity, whichever is the less. Lifting capacities marked* are based on hydraulic capacity.
3. Lift capacities assume that the machine is on firm, level ground.
4. Lift capacities may be limited by local regulations. Please refer to your dealer.





ONE COMPANY, OVER 300 MACHINES.

Your nearest JCB dealer

Tracked Excavator JZ140 LC/HD

Gross engine power: 81 kW (109 hp)

Bucket capacity: 0.35 – 0.89m³ Operating weight: 15084 – 17880kg

JCB Sales Limited, Rokester, Staffordshire, United Kingdom ST14 5JP.

Tel: +44 (0)1889 590312 Email: salesinfo@jcb.com

Download the very latest information on this product range at: www.jcb.com

©2015 JCB Sales. All rights reserved. No part of this publication may be reproduced, stored in a retrieval system, or transmitted in any form or by any other means, electronic, mechanical, photocopying or otherwise, without prior permission from JCB Sales. All references in this publication to operating weights, sizes, capacities and other performance measurements are provided for guidance only and may vary dependant upon the exact specification of machine. They should not therefore be relied upon in relation to suitability for a particular application. Guidance and advice should always be sought from your JCB Dealer. JCB reserves the right to change specifications without notice. Illustrations and specifications shown may include optional equipment and accessories. All images are correct at time of print. The JCB logo is a registered trademark of J C Bamford Excavators Ltd.



9999/5967 en-GB 04/16 Issue 1 (T4)

