

www.myperformanceplus.de

performance
plus

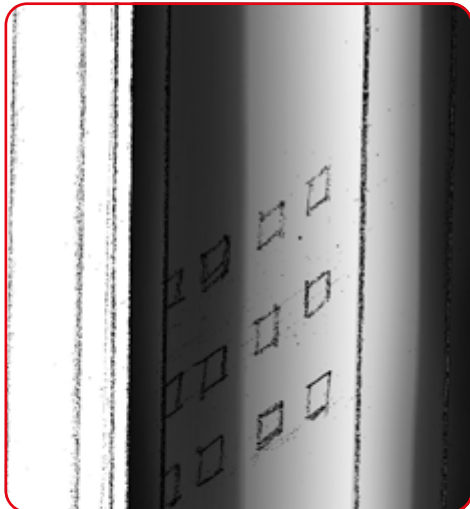
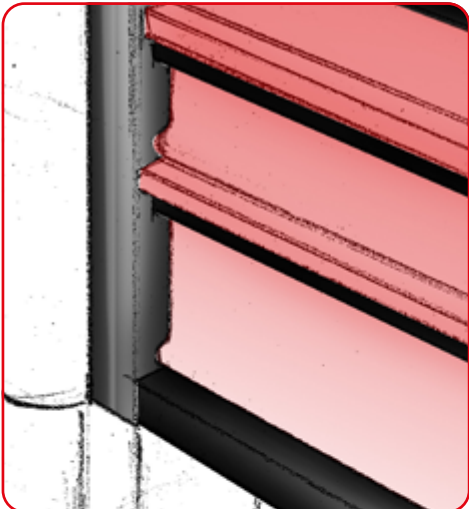
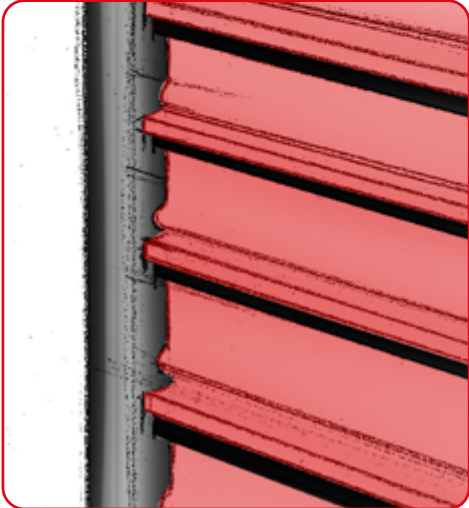
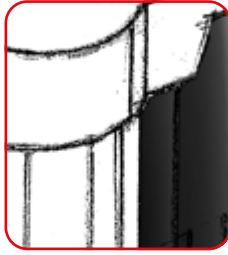
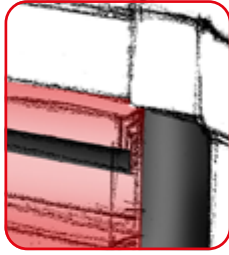
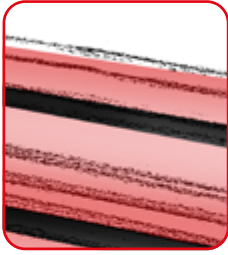
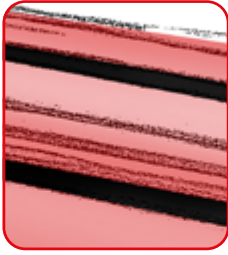
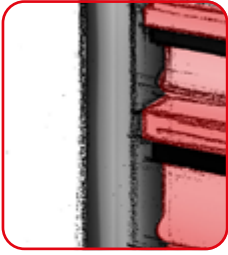
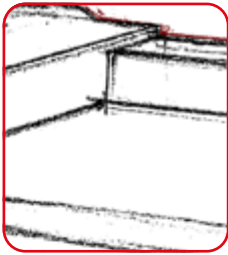
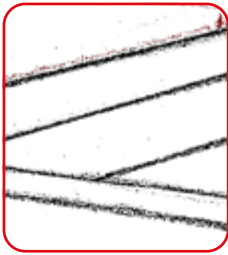

KS TOOLS

EXPERIENCE THE NEW
PREMIUM
WORKSHOP TROLLEYS

P25

THE BROAD ONE WITH GREAT CONTENT



3.099,- €

825.8564

including 564 tools >>

PERFORMANCE PLUS



Brilliant **DUO Lock** locking system



8 drawers each load capacity up to 50 kg



Stable **ball bearing**



Stainless steel worktop

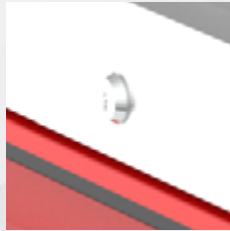

Lock lockable

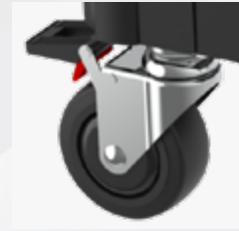

Anti-static castors with brakes



Integrated **corner protection**



Paper roll holder included



Can holder included

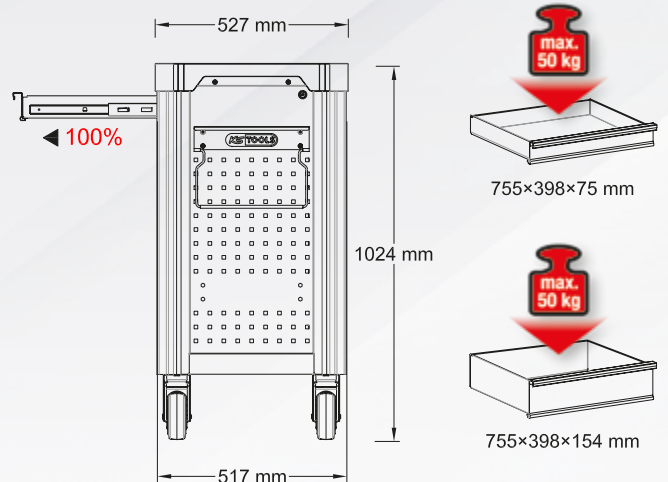
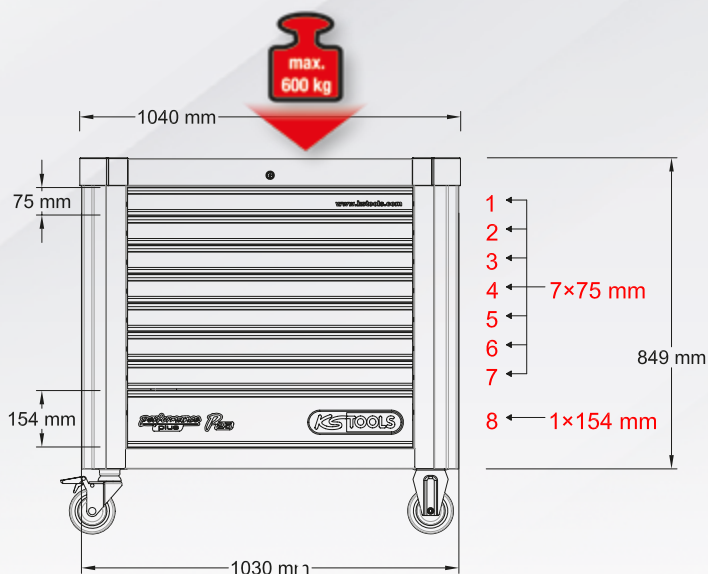

**COMPLETELY ASSEMBLED AND
EQUIPPED WITH 564 QUALITY TOOLS.
FOR MORE WIDTH AT THE TOP.**

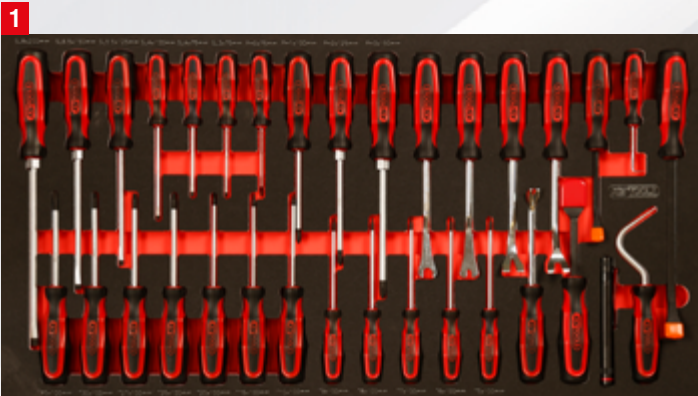

SCS ERGOTORQUEPLUS SCREWDRIVER SET, 33 PCS



SCS 1/4" + 3/8" SOCKET WRENCH SET, 213 PCS

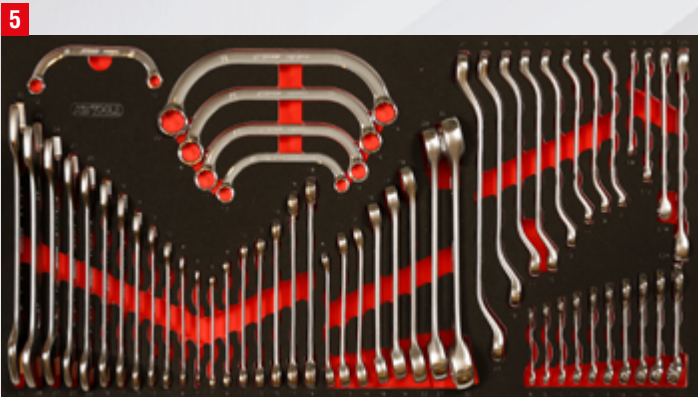

SCS WRENCH SET, 54 PCS

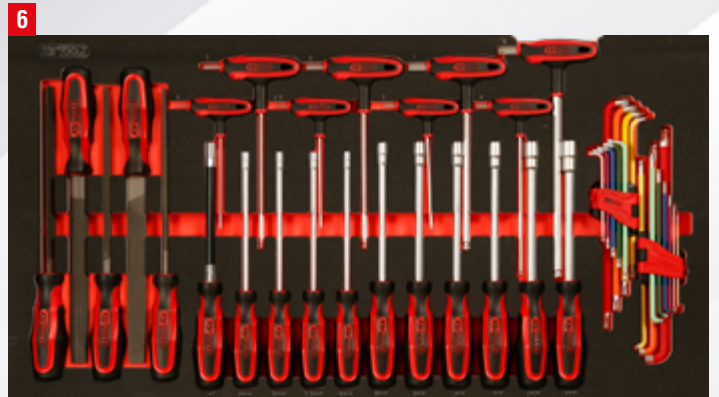

SCS FILE AND OFFSET KEY SET, 42 PCS



PERFORMANCE MAK



Scan the QR code
for a detailed
range list

3



SCS 1/2" SOCKET WRENCH SET, 86 PCS



4

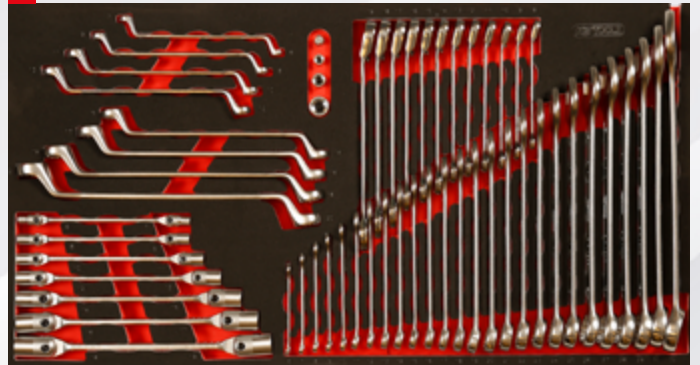

SCS WRENCH SET, 57 PCS



6-32 mm

7



SCS PLIERS AND MEASURING TOOL SET, 39 PCS



8



SCS 1/2" IMPACT SOCKET WRENCH AND HAMMER SET, 40 PCS



MAKES YOU SUCCESSFUL

813.0033

L Screwdriver set

179,-^{EUR}



755 x 398

P25

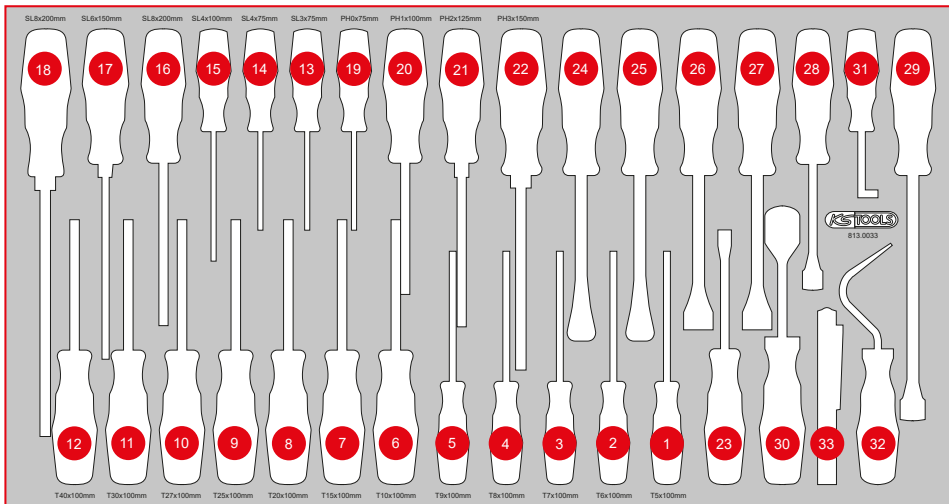
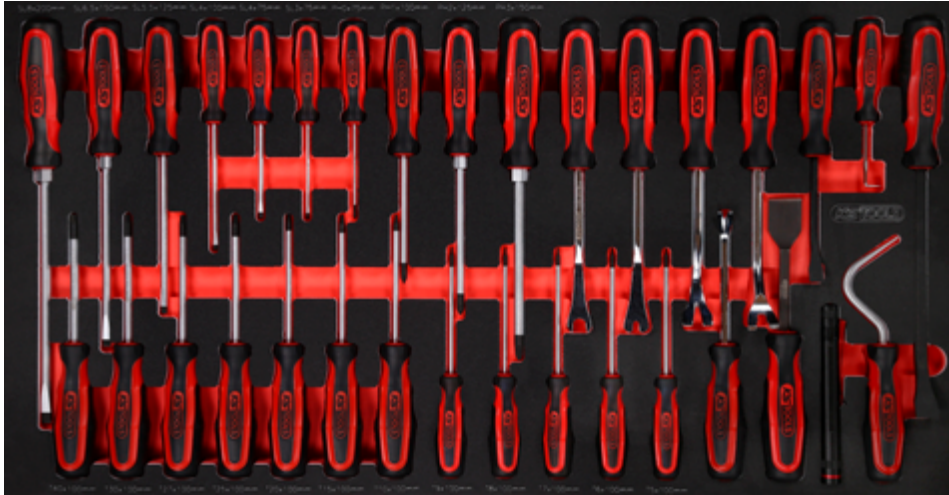

Pos.	Code	Description	pcs
1	159.1133	ERGOTORQUEplus screwdriver, Torx, T5	1
2	159.1134	ERGOTORQUEplus screwdriver, Torx, T6	1
3	159.1135	ERGOTORQUEplus screwdriver, Torx, T7	1
4	159.1030	ERGOTORQUEplus screwdriver, Torx, T8	1
5	159.1031	ERGOTORQUEplus screwdriver, Torx, T9	1
6	159.1032	ERGOTORQUEplus screwdriver, Torx, T10	1
7	159.1033	ERGOTORQUEplus screwdriver, Torx, T15	1
8	159.1034	ERGOTORQUEplus screwdriver, Torx, T20	1
9	159.1035	ERGOTORQUEplus screwdriver, Torx, T25	1
10	159.1036	ERGOTORQUEplus screwdriver, Torx, T27	1
11	159.1037	ERGOTORQUEplus screwdriver, Torx, T30	1
12	159.1038	ERGOTORQUEplus screwdriver, Torx, T40	1
13	159.1002	ERGOTORQUEplus screwdriver for slotted screws, 3 mm, 155 mm long	1
14	159.1003	ERGOTORQUEplus screwdriver for slotted screws, 4 mm, 155 mm long	1
15	159.1004	ERGOTORQUEplus screwdriver for slotted screws, 4 mm, 180 mm long	1
16	159.1006	ERGOTORQUEplus screwdriver for slotted screws, 5,5 mm, 230 mm long	1
17	159.1009	ERGOTORQUEplus screwdriver for slotted screws, 6,5 mm, 255 mm long	1
18	159.1011	ERGOTORQUEplus screwdriver for slotted screws, 8 mm, 315 mm long	1
19	159.1027	ERGOTORQUEplus screwdriver, Torx, PH0, 155 mm	1
20	159.1029	ERGOTORQUEplus screwdriver, Torx, PH1, 205 mm	1
21	159.1022	ERGOTORQUEplus screwdriver, Torx, PH2, 230 mm	1
22	159.1024	ERGOTORQUEplus screwdriver, Torx, PH3, 265 mm	1
23	140.2617	Clip remover short, length 240 mm, opening 5 mm	1
24	140.2373	Clip remover short, length 245 mm, opening 10 mm	1
25	140.2371	Clip remover short, length 245 mm, opening 4 mm	1
26	140.2616	Clip remover, short 7,5 mm	1
27	140.2615	Clip remover, short 9 mm	1
28	911.8101	Pry bar, 11 x 115 mm	1
29	911.8102	Pry bar, 15 x 185 mm	1
30	907.2232	Gasket scraper, 25 x 200 mm	1
31	550.1048	Hook, 90° offset	1
32	550.1073	Hook, large, sickle	1
33	150.4370	perfectLight torch 85 lumen	1

813.0213

L 1/4" + 3/8" Socket spanner set

629,^{EUR}-



IPCS
213



755 x 398

P25

Pos.	Code	Description	pcs	Pos.	Code	Description	pcs	Pos.	Code	Description	pcs
1	911.3915	3/8" Bit socket spline (XZN), M5	1	39	917.3923	3/8" RIBE® Bit socket, M6	1	77	911.1419	1/4" Bit socket slot, 5,5 mm	1
2	911.3916	3/8" Bit socket spline (XZN), M6	1	40	917.3924	3/8" RIBE® Bit socket, M7	1	78	917.1421	1/4" Bit socket slot, 6,5 mm	1
3	911.3917	3/8" Bit socket spline (XZN), M8	1	41	917.3925	3/8" RIBE® Bit socket, M8	1	79	911.1701	1/4" Bit socket five star tamperproof, TS10	1
4	917.3901	3/8" Bit socket spline (XZN), M9	1	42	917.3926	3/8" RIBE® Bit socket, M9	1	80	911.1702	1/4" Bit socket five star tamperproof, TS15	1
5	911.3920	3/8" Bit socket spline (XZN), M10	1	43	917.3927	3/8" RIBE® Bit socket, M10	1	81	911.1703	1/4" Bit socket five star tamperproof, TS20	1
6	917.3903	3/8" Bit socket spline (XZN), M12	1	44	917.3928	3/8" RIBE® Bit socket, M12	1	82	911.1704	1/4" Bit socket five star tamperproof, TS25	1
7	911.3934	3/8" Bit socket Torx, T8	1	45	911.3863	3/8" Bit socket hexagon, 3 mm	1	83	911.1705	1/4" Bit socket five star tamperproof, TS27	1
8	911.3887	3/8" Bit socket Torx, T10	1	46	911.3864	3/8" Bit socket hexagon, 4 mm	1	84	911.1706	1/4" Bit socket five star tamperproof, TS30	1
9	911.3869	3/8" Bit socket Torx, T15	1	47	911.3865	3/8" Bit socket hexagon, 5 mm	1	85	911.1707	1/4" Bit socket five star tamperproof, TS40	1
10	911.3870	3/8" Bit socket Torx, T20	1	48	911.38655	3/8" Bit socket hexagon, 5,5 mm	1	86	911.1461	1/4" Bit socket Torx tamperproof, TB8	1
11	911.3871	3/8" Bit socket Torx, T25	1	49	911.3866	3/8" Bit socket hexagon, 6 mm	1	87	911.1462	1/4" Bit socket Torx tamperproof, TB10	1
12	911.3872	3/8" Bit socket Torx, T27	1	50	911.3867	3/8" Bit socket hexagon, 7 mm	1	88	911.1463	1/4" Bit socket Torx tamperproof, TB15	1
13	911.3873	3/8" Bit socket Torx, T30	1	51	911.3868	3/8" Bit socket hexagon, 8 mm	1	89	911.1464	1/4" Bit socket Torx tamperproof, TB20	1
14	911.3874	3/8" Bit socket Torx, T40	1	52	917.3969	3/8" Bit socket hexagon, 9 mm	1	90	911.1465	1/4" Bit socket Torx tamperproof, TB25	1
15	911.3885	3/8" Bit socket Torx, T45	1	53	917.3857	3/8" Bit socket hexagon, 10 mm	1	91	911.1466	1/4" Bit socket Torx tamperproof, TB27	1
16	911.3884	3/8" Bit socket Torx, T50	1	54	911.3862	3/8" Bit socket hexagon, 12 mm	1	92	911.1467	1/4" Bit socket Torx tamperproof, TB30	1
17	911.3888	3/8" Bit socket Torx, T55	1	55	911.3878	3/8" Bit socket slot, 5,5 mm	1	93	911.1468	1/4" Bit socket Torx tamperproof, TB40	1
18	911.3889	3/8" Bit socket Torx, T60	1	56	911.3943	3/8" Bit socket slot 6 mm	1	94	911.1483	1/4" Bit socket, PZ0	1
19	911.3875	3/8" Bit socket, PH1	1	57	911.3944	3/8" Bit socket slot 7 mm	1	95	911.1401	1/4" Bit socket, PZ1	1
20	911.3876	3/8" Bit socket, PH2	1	58	911.1436	1/4" Bit socket hexagon, 3 mm	1	96	911.1402	1/4" Bit socket, PZ2	1
21	911.3877	3/8" Bit socket, PH3	1	59	911.1437	1/4" Bit socket hexagon, 4 mm	1	97	917.3806	3/8" Hexagonal socket, 6 mm	1
22	911.3881	3/8" Bit socket, PZ1	1	60	911.1438	1/4" Bit socket hexagon, 5 mm	1	98	917.3807	3/8" Hexagonal socket, 7 mm	1
23	911.3882	3/8" Bit socket, PZ2	1	61	911.1439	1/4" Bit socket hexagon, 6 mm	1	99	917.3808	3/8" Hexagonal socket, 8 mm	1
24	911.3883	3/8" Bit socket, PZ3	1	62	911.1440	1/4" Bit socket hexagon, 7 mm	1	100	917.3809	3/8" Hexagonal socket, 9 mm	1
25	917.3929	3/8" Bit socket Torx tamperproof, TB8	1	63	911.1441	1/4" Bit socket hexagon, 8 mm	1	101	917.3810	3/8" Hexagonal socket, 10 mm	1
26	911.3960	3/8" Bit socket Torx tamperproof, TB10	1	64	917.1452	1/4" Bit socket hexagon, 10 mm	1	102	917.3811	3/8" Hexagonal socket, 11 mm	1
27	911.3961	3/8" Bit socket Torx tamperproof, TB15	1	65	911.1448	1/4" Bit socket Torx, T8	1	103	917.3812	3/8" Hexagonal socket, 12 mm	1
28	911.3962	3/8" Bit socket Torx tamperproof, TB20	1	66	911.1442	1/4" Bit socket Torx, T10	1	104	917.3813	3/8" Hexagonal socket, 13 mm	1
29	911.3963	3/8" Bit socket Torx tamperproof, TB25	1	67	911.1443	1/4" Bit socket Torx, T15	1	105	917.3814	3/8" Hexagonal socket, 14 mm	1
30	911.3964	3/8" Bit socket Torx tamperproof, TB27	1	68	911.1444	1/4" Bit socket Torx, T20	1	106	917.3815	3/8" Hexagonal socket, 15 mm	1
31	911.3965	3/8" Bit socket Torx tamperproof, TB30	1	69	911.1445	1/4" Bit socket Torx, T25	1	107	917.3816	3/8" Hexagonal socket, 16 mm	1
32	911.3966	3/8" Bit socket Torx tamperproof, TB40	1	70	911.1449	1/4" Bit socket Torx, T27	1	108	917.3817	3/8" Hexagonal socket, 17 mm	1
33	911.3967	3/8" Bit socket Torx tamperproof, TB45	1	71	911.1446	1/4" Bit socket Torx, T30	1	109	917.3818	3/8" Hexagonal socket, 18 mm	1
34	911.3968	3/8" Bit socket Torx tamperproof, TB50	1	72	911.1447	1/4" Bit socket Torx, T40	1	110	917.3819	3/8" Hexagonal socket, 19 mm	1
35	911.3969	3/8" Bit socket Torx tamperproof, TB55	1	73	911.1482	1/4" Bit socket, PH0	1	111	917.3820	3/8" Hexagonal socket, 20 mm	1
36	911.3970	3/8" Bit socket Torx tamperproof, TB60	1	74	911.1415	1/4" Bit socket, PH1	1	112	917.3821	3/8" Hexagonal socket, 21 mm	1
37	917.3921	3/8" RIBE® Bit socket, M4	1	75	911.1416	1/4" Bit socket, PH2	1	113	917.3822	3/8" Hexagonal socket, 22 mm	1
38	917.3922	3/8" RIBE® Bit socket, M5	1	76	911.1418	1/4" Bit socket slot, 4 mm	1	114	911.0101	1/4" socket with magnet	1

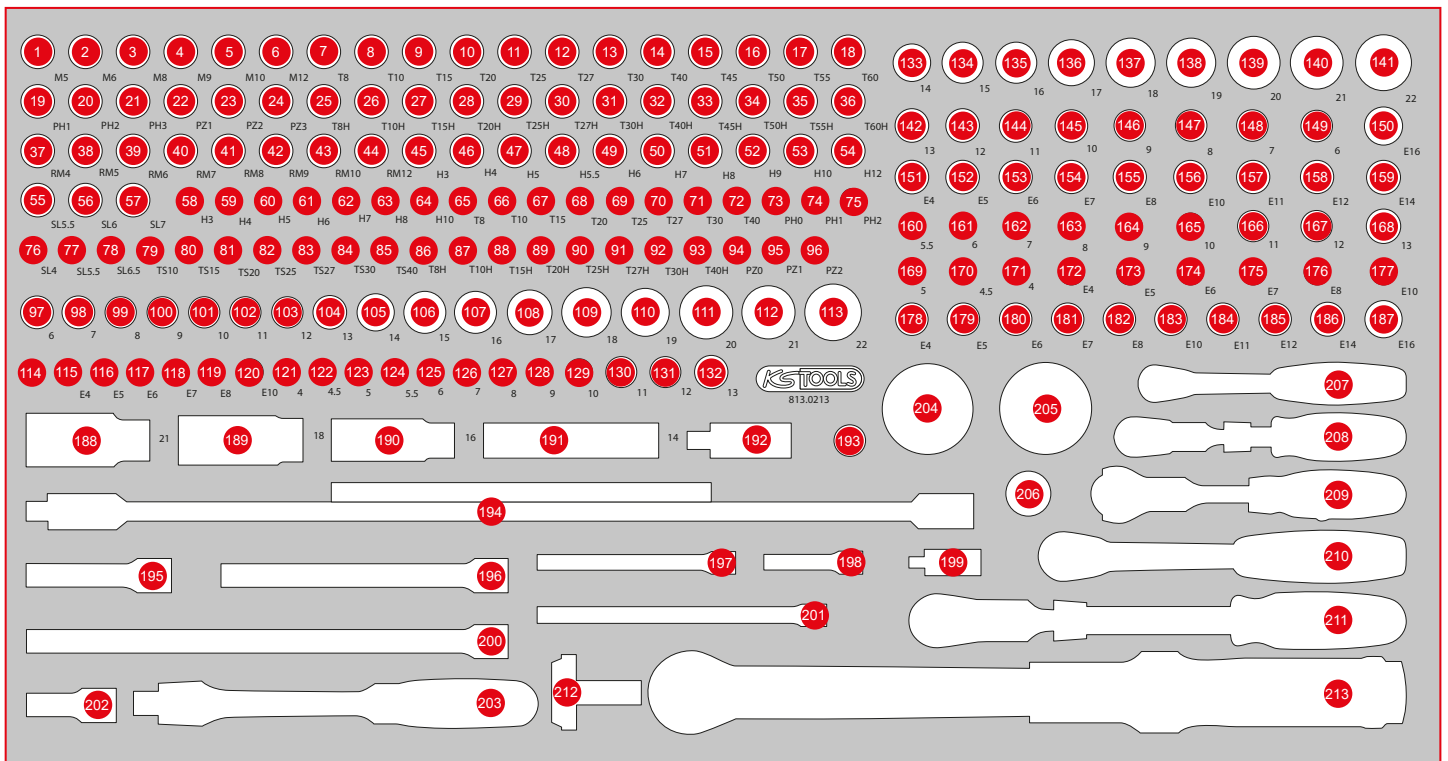

Pos.	Code	Description	pcs	Pos.	Code	Description	pcs	Pos.	Code	Description	pcs
115	911.4313	1/4" Torx E Socket, E4	1	153	911.4386	3/8" Torx E socket, E6, long	1	191	911.3999	3/8" Special spark plug socket for BMW with flexible joint, 14mm	1
116	911.4314	1/4" Torx E Socket, E5	1	154	911.4387	3/8" Torx E socket, E7, long	1	192	911.3850	3/8" Universal joint	1
117	911.4315	1/4" Torx E Socket, E6	1	155	911.4388	3/8" Torx E socket, E8, long	1	193	911.3897	3/8" Reducing adaptor, 3/8"F x 1/4"M	1
118	911.4316	1/4" Torx E Socket, E7	1	156	911.4390	3/8" Torx E socket, E10, long	1	194	517.1126	T-Handle universal wrench for sockets, extra long, 3/8"	1
119	911.4317	1/4" Torx E Socket, E8	1	157	911.4391	3/8" Torx E socket, E11, long	1	195	911.3801	3/8" Extension with knurling, 75 mm	1
120	911.4332	1/4" Torx E Socket, E10	1	158	911.4392	3/8" Torx E socket, E12, long	1	196	911.3802	3/8" Extension with knurling, 150 mm	1
121	917.1404	1/4" Hexagonal socket, 4 mm	1	159	911.4394	3/8" Torx E socket, E14, long	1	197	911.1424	1/4" Extension with hexagon drive, 100 mm	1
122	917.14045	1/4" Hexagonal socket, 4,5 mm	1	160	917.1528	1/4" Hexagonal socket, deep, 5,5 mm	1	198	911.1423	1/4" Extension with hexagon drive, 50 mm	1
123	917.1405	1/4" Hexagonal socket, 5 mm	1	161	917.1426	1/4" Hexagonal socket, deep, 6 mm	1	199	911.1450	1/4" Universal joint	1
124	917.14055	1/4" Hexagonal socket, 5,5 mm	1	162	917.1427	1/4" Hexagonal socket, deep, 7 mm	1	200	911.3803	3/8" Extension with knurling, 250 mm	1
125	917.1406	1/4" Hexagonal socket, 6 mm	1	163	917.1428	1/4" Hexagonal socket, deep, 8 mm	1	201	911.1451	1/4" Extension with hexagon drive, 150 mm	1
126	917.1407	1/4" Hexagonal socket, 7 mm	1	164	917.1429	1/4" Hexagonal socket, deep, 9 mm	1	202	911.3852	3/8" Extension with knurling, 45 mm	1
127	917.1408	1/4" Hexagonal socket, 8 mm	1	165	917.1430	1/4" Hexagonal socket, deep, 10 mm	1	203	917.3939	3/8" Flexi head drive handle	1
128	917.1409	1/4" Hexagonal socket, 9 mm	1	166	917.1431	1/4" Hexagonal socket, deep, 11 mm	1	204	914.1410	Mini hand reversible ratchet, 1/4", 72 teeth	1
129	917.1410	1/4" Hexagonal socket, 10 mm	1	167	917.1432	1/4" Hexagonal socket, deep, 12 mm	1	205	914.3810	Mini hand reversible ratchet, 3/8", 72 teeth	1
130	917.1411	1/4" Hexagonal socket, 11 mm	1	168	917.1433	1/4" Hexagonal socket, deep, 13 mm	1	206	911.3826	3/8" Sliding / reducing adaptor, 1/2"F x 3/8"M	1
131	917.1412	1/4" Hexagonal socket, 12 mm	1	169	917.1527	1/4" Hexagonal socket, deep, 5 mm	1	207	920.1490	1/4" SlimPOWER Reversible ratchet, 72 teeth	1
132	917.1413	1/4" Hexagonal socket, 13 mm	1	170	917.1526	1/4" Hexagonal socket, deep, 4,5 mm	1	208	914.1420	1/4" SlimPOWER telescopic-joint reversible ratchet, 72 teeth	1
133	917.3834	3/8" Hexagonal socket, deep, 14 mm	1	171	917.1525	1/4" Hexagonal socket, deep, 4 mm	1	209	914.1405	1/4" MODIFIX mini T-handle swivel head ratchet, 72 teeth	1
134	917.3835	3/8" Hexagonal socket, deep, 15 mm	1	172	917.2401	1/4" Torx E Socket, deep, E4	1	210	920.3890	3/8" SlimPOWER Reversible ratchet, 72 teeth	1
135	917.3836	3/8" Hexagonal socket, deep, 16 mm	1	173	917.2402	1/4" Torx E Socket, deep, E5	1	211	914.3820	3/8" SlimPOWER Telescopic reversible ratchet, 72 teeth	1
136	917.3837	3/8" Hexagonal socket, deep, 17 mm	1	174	917.2403	1/4" Torx E Socket, deep, E6	1	212	516.1428	Rotary square box wrench, 1/2"x3/8"	1
137	917.3838	3/8" Hexagonal socket, deep, 18 mm	1	175	917.2404	1/4" Torx E Socket, deep, E7	1	213	516.1432	1/2" ERGOTORQUE® precision torque wrench with rotary mushroom ratchet head, 20-100Nm	1
138	917.3839	3/8" Hexagonal socket, deep, 19 mm	1	176	917.2405	1/4" Torx E Socket, deep, E8	1				
139	917.3840	3/8" Hexagonal socket, deep, 20 mm	1	177	917.2406	1/4" Torx E Socket, deep, E10	1				
140	917.3841	3/8" Hexagonal socket, deep, 21 mm	1	178	911.4338	3/8" Torx E Socket, E4	1				
141	917.3842	3/8" Hexagonal socket, deep, 22 mm	1	179	911.4339	3/8" Torx E Socket, E5	1				
142	917.3833	3/8" Hexagonal socket, deep, 13 mm	1	180	911.4340	3/8" Torx E Socket, E6	1				
143	917.3832	3/8" Hexagonal socket, deep, 12 mm	1	181	911.4341	3/8" Torx E Socket, E7	1				
144	917.3831	3/8" Hexagonal socket, deep, 11 mm	1	182	911.4342	3/8" Torx E Socket, E8	1				
145	917.3830	3/8" Hexagonal socket, deep, 10 mm	1	183	911.4318	3/8" Torx E Socket, E10	1				
146	917.3829	3/8" Hexagonal socket, deep, 9 mm	1	184	911.4319	3/8" Torx E Socket, E11	1				
147	917.3828	3/8" Hexagonal socket, deep, 8 mm	1	185	911.4320	3/8" Torx E Socket, E12	1				
148	917.4807	3/8" Hexagonal socket, deep, 7 mm	1	186	911.4321	3/8" Torx E Socket, E14	1				
149	917.4806	3/8" Hexagonal socket, deep, 6 mm	1	187	911.4343	3/8" Torx E Socket, E16	1				
150	911.4396	3/8" Torx E socket, E16, long	1	188	911.3805	3/8" Spark plug socket, 21 mm	1				
151	911.4384	3/8" Torx E socket, E4, long	1	189	911.3823	3/8" Spark plug socket, 18 mm	1				
152	911.4385	3/8" Torx E socket, E5, long	1	190	911.3804	3/8" Spark plug socket, 16 mm	1				

813.0086

L 1/2" Socket spanner set

439,^{EUR}—



86

755 x 398 P25

Pos.	Code	Description	pcs	Pos.	Code	Description	pcs	Pos.	Code	Description	pcs
1	917.1252	1/2" Hexagonal socket, deep, 22 mm	1	16	917.1258	1/2" Hexagonal socket, deep, 20 mm	1	31	917.1343	1/2" Hexagonal socket, 26 mm	1
2	917.1315	1/2" Hexagonal socket, deep, 23 mm	1	17	917.1259	1/2" Hexagonal socket, deep, 21 mm	1	32	917.1227	1/2" Hexagonal socket, 27 mm	1
3	917.1257	1/2" Hexagonal socket, deep, 24 mm	1	18	917.1313	1/2" Hexagonal socket, deep, 8 mm	1	33	917.1344	1/2" Hexagonal socket, 28 mm	1
4	917.1337	1/2" Hexagonal socket, deep, 26 mm	1	19	917.1309	1/2" Hexagonal socket, deep, 9 mm	1	34	917.1230	1/2" Hexagonal socket, 30 mm	1
5	917.1254	1/2" Hexagonal socket, deep, 27 mm	1	20	917.1240	1/2" Hexagonal socket, deep, 10 mm	1	35	917.1232	1/2" Hexagonal socket, 32 mm	1
6	917.1338	1/2" Hexagonal socket, deep, 28 mm	1	21	917.1241	1/2" Hexagonal socket, deep, 11 mm	1	36	917.1221	1/2" Hexagonal socket, 21 mm	1
7	917.1255	1/2" Hexagonal socket, deep, 30 mm	1	22	917.1242	1/2" Hexagonal socket, deep, 12 mm	1	37	917.1220	1/2" Hexagonal socket, 20 mm	1
8	917.1256	1/2" Hexagonal socket, deep, 32 mm	1	23	515.0991	SlimPOWER 1/2"Alloy rim impact socket, 15 mm	1	38	917.1219	1/2" Hexagonal socket, 19 mm	1
9	917.1243	1/2" Hexagonal socket, deep, 13 mm	1	24	515.0992	SlimPOWER 1/2"Alloy rim impact socket, 17 mm	1	39	917.1218	1/2" Hexagonal socket, 18 mm	1
10	917.1244	1/2" Hexagonal socket, deep, 14 mm	1	25	515.0993	SlimPOWER 1/2"Alloy rim impact socket, 19 mm	1	40	917.1217	1/2" Hexagonal socket, 17 mm	1
11	917.1245	1/2" Hexagonal socket, deep, 15 mm	1	26	515.0994	SlimPOWER 1/2"Alloy rim impact socket, 21 mm	1	41	917.1216	1/2" Hexagonal socket, 16 mm	1
12	917.1246	1/2" Hexagonal socket, deep, 16 mm	1	27	515.0995	SlimPOWER 1/2"Alloy rim impact socket, 22 mm	1	42	917.1215	1/2" Hexagonal socket, 15 mm	1
13	917.1247	1/2" Hexagonal socket, deep, 17 mm	1	28	917.1222	1/2" Hexagonal socket, 22 mm	1	43	917.1214	1/2" Hexagonal socket, 14 mm	1
14	917.1248	1/2" Hexagonal socket, deep, 18 mm	1	29	917.1223	1/2" Hexagonal socket, 23 mm	1	44	917.1213	1/2" Hexagonal socket, 13 mm	1
15	917.1249	1/2" Hexagonal socket, deep, 19 mm	1	30	917.1224	1/2" Hexagonal socket, 24 mm	1	45	917.1212	1/2" Hexagonal socket, 12 mm	1

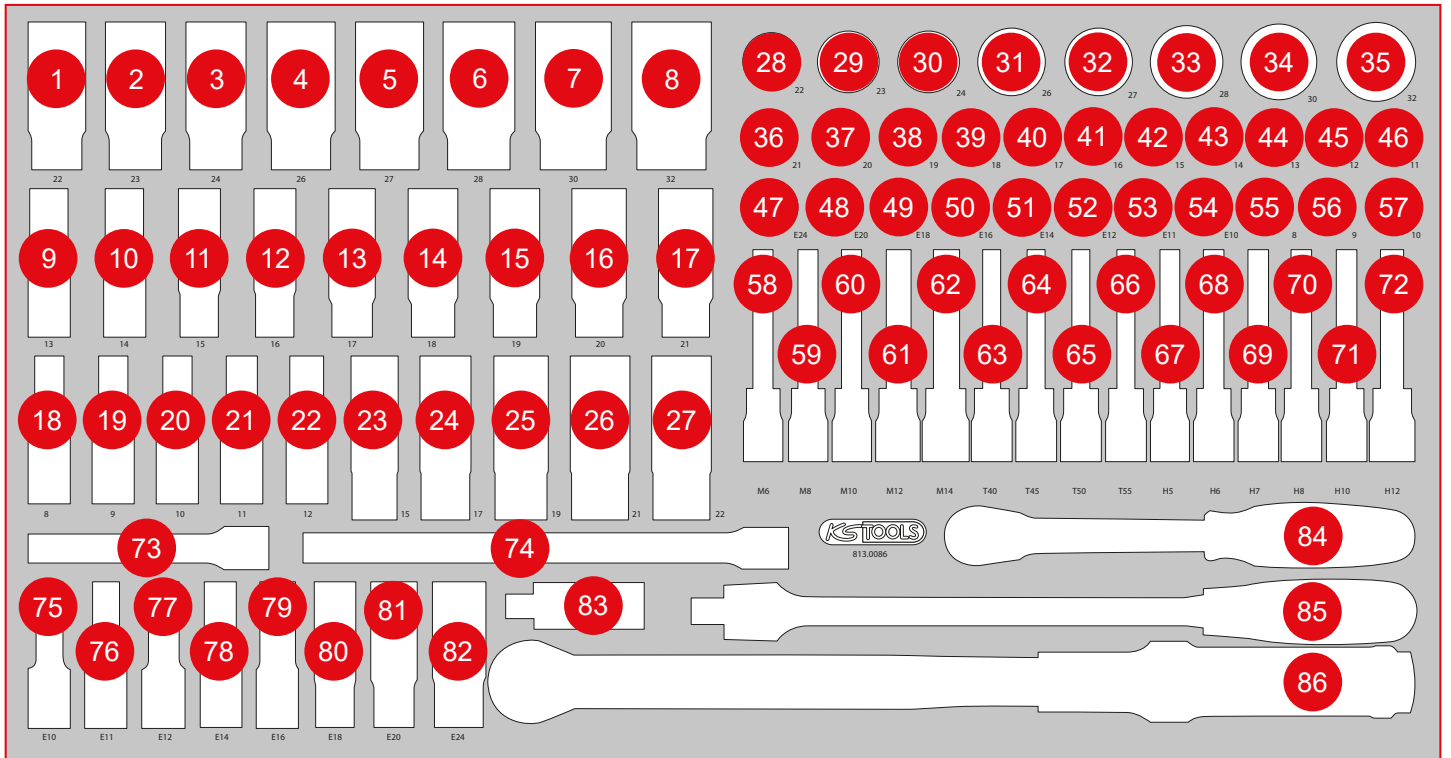

Pos.	Code	Description	pcs	Pos.	Code	Description	pcs	Pos.	Code	Description	pcs
46	917.1211	1/2" Hexagonal socket, 11 mm	1	61	911.1354	1/2" Bit socket spline (XZN), M12, 110 mm	1	75	911.4423	1/2" Torx E Socket, 78 mm long, E10	1
47	911.4326	1/2" Torx E Socket, E24	1	62	911.1355	1/2" Bit socket spline (XZN), M14, 110 mm	1	76	911.4424	1/2" Torx E Socket, deep, E11	1
48	911.4324	1/2" Torx E Socket, E20	1	63	911.1525	1/2" Bit socket Torx, long, T40	1	77	911.4425	1/2" Torx E Socket, 78 mm, E12	1
49	911.4323	1/2" Torx E Socket, E18	1	64	911.1526	1/2" Bit socket Torx, long, T45	1	78	911.4426	1/2" Torx E Socket, 78 mm, E14	1
50	911.4322	1/2" Torx E Socket, E16	1	65	911.1527	1/2" Bit socket Torx, long, T50	1	79	911.4427	1/2" Torx E Socket, 78 mm, E16	1
51	911.4336	1/2" Torx E Socket, E14	1	66	911.1528	1/2" Bit socket Torx, long, T55	1	80	911.4428	1/2" Torx E Socket, 78 mm, E18	1
52	911.4335	1/2" Torx E Socket, E12	1	67	911.1325	1/2" Bit socket hexagon, long, 5 mm	1	81	911.4429	1/2" Torx E Socket, 78 mm, E20	1
53	911.4334	1/2" Torx E Socket, E11	1	68	911.1326	1/2" Bit socket hexagon, long, 6 mm	1	82	911.4431	1/2" Torx E Socket, deep, E24	1
54	911.4333	1/2" Torx E Socket, E10	1	69	911.1327	1/2" Bit socket hexagon, long, 7 mm	1	83	911.1250	1/2" Universal joint	1
55	917.1340	1/2" Hexagonal socket, 8 mm	1	70	911.1328	1/2" Bit socket hexagon, long, 8 mm	1	84	516.1442	1/2" ERGOTORQUE® precision torque wrench with rotary mushroom ratchet head, 40-200Nm	1
56	917.1341	1/2" Hexagonal socket, 9 mm	1	71	911.1330	1/2" Bit socket hexagon, long, 10 mm	1	85	917.1455	1/2" Flexi head drive handle	1
57	917.1210	1/2" Hexagonal socket, 10 mm	1	72	911.1332	1/2" Bit socket hexagon, long, 12 mm	1	86	920.1290	1/2" SlimPOWER Reversible ratchet, 72 teeth	1
58	911.1351	1/2" Bit socket spline (XZN), M6, 110 mm	1	73	911.1202	1/2" Extensions, 125 mm	1				
59	911.1352	1/2" Bit socket spline (XZN), M8, 110 mm	1	74	911.1203	1/2" Extensions, 250 mm	1				
60	911.1353	1/2" Bit socket spline (XZN), M10, 110 mm	1								

813.0057

L Screw spanner set

499,^{EUR}—

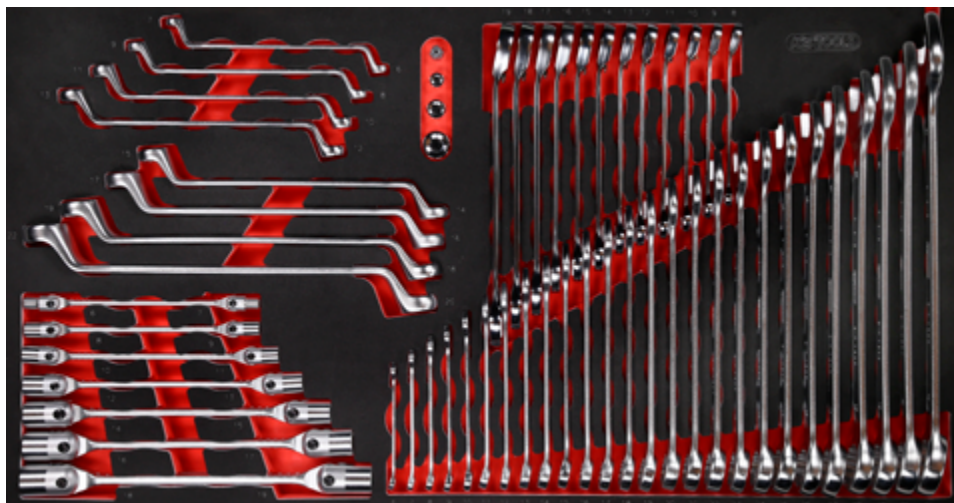

IPCS
57



755 x 398

P25

Pos.	Code	Description	pcs
1	517.0606	Combination spanners, offset, 6 mm	1
2	517.0607	Combination spanners, offset, 7 mm	1
3	517.0608	Combination spanners, offset, 8 mm	1
4	517.0609	Combination spanners, offset, 9 mm	1
5	517.0610	Combination spanners, offset, 10 mm	1
6	517.0611	Combination spanners, offset, 11 mm	1
7	517.0612	Combination spanners, offset, 12 mm	1
8	517.0613	Combination spanners, offset, 13 mm	1
9	517.0614	Combination spanners, offset, 14 mm	1
10	517.0615	Combination spanners, offset, 15 mm	1
11	517.0616	Combination spanners, offset, 16 mm	1
12	517.0617	Combination spanners, offset, 17 mm	1

Pos.	Code	Description	pcs
13	517.0618	Combination spanners, offset, 18 mm	1
14	517.0619	Combination spanners, offset, 19 mm	1
15	517.0620	Combination spanners, offset, 20 mm	1
16	517.0621	Combination spanners, offset, 21 mm	1
17	517.0622	Combination spanners, offset, 22 mm	1
18	517.0623	Combination spanners, offset, 23 mm	1
19	517.0624	Combination spanners, offset, 24 mm	1
20	517.0625	Combination spanners, offset, 25 mm	1
21	517.0626	Combination spanners, offset, 26 mm	1
22	517.0627	Combination spanners, offset, 27 mm	1
23	517.0628	Combination spanners, offset, 28 mm	1
24	517.0629	Combination spanners, offset, 29 mm	1

Pos.	Code	Description	pcs
25	517.0630	Combination spanners, offset, 30 mm	1
26	517.0632	Combination spanners, offset, 32 mm	1
27	503.4608	GEARplus reversing combination ratcheting spanner, 8 mm	1
28	503.4609	GEARplus reversing combination ratcheting spanner, 9 mm	1
29	503.4610	GEARplus reversing combination ratcheting spanner, 10 mm	1
30	503.4611	GEARplus reversing combination ratcheting spanner, 11 mm	1
31	503.4612	GEARplus reversing combination ratcheting spanner, 12 mm	1
32	503.4613	GEARplus reversing combination ratcheting spanner, 13 mm	1

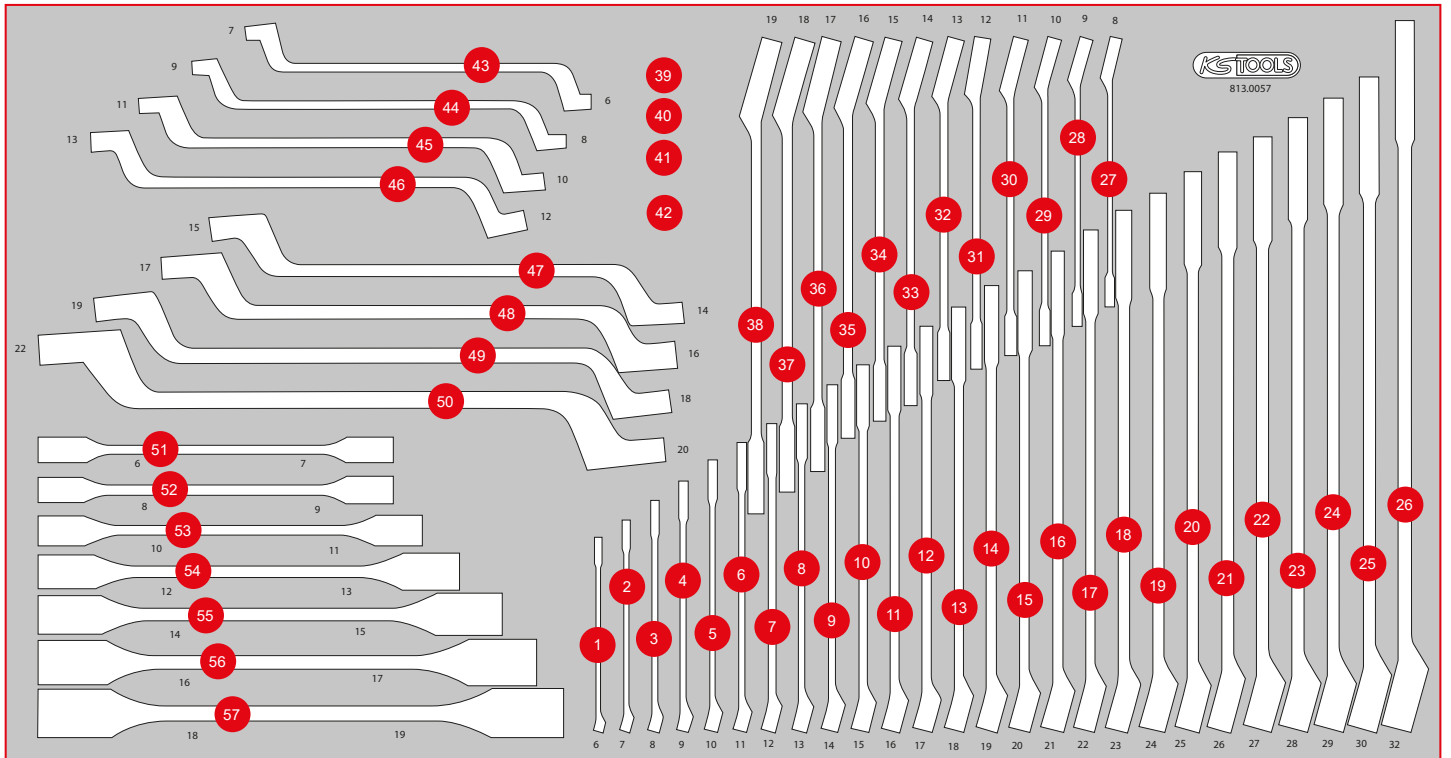

Pos.	Code	Description	pcs	Pos.	Code	Description	pcs	Pos.	Code	Description	pcs
33	503.4614	GEARplus reversing combination ratcheting spanner, 14 mm	1	41	503.4297	GEARplus socket adaptor, 3/8" x 13 mm	1	53	517.0302	Double revolving head spanner, 10 x 11 mm	1
34	503.4615	GEARplus reversing combination ratcheting spanner, 15 mm	1	42	503.4298	GEARplus socket adaptor, 1/2" x 19 mm	1	54	517.0303	Double revolving head spanner, 12 x 13 mm	1
35	503.4616	GEARplus reversing combination ratcheting spanner, 16 mm	1	43	517.0801	Double ring spanner, offset, 6 x 7 mm	1	55	517.0304	Double revolving head spanner, 14 x 15 mm	1
36	503.4617	GEARplus reversing combination ratcheting spanner, 17 mm	1	44	517.0802	Double ring spanner, offset, 8 x 9 mm	1	56	517.0305	Double revolving head spanner, 16 x 17 mm	1
37	503.4618	GEARplus reversing combination ratcheting spanner, 18 mm	1	45	517.0804	Double ring spanner, offset, 10 x 11 mm	1	57	517.0306	Double revolving head spanner, 18 x 19 mm	1
38	503.4619	GEARplus reversing combination ratcheting spanner, 19 mm	1	46	517.0807	Double ring spanner, offset, 12 x 13 mm	1				
39	503.4290	GEARplus bit adaptor, 1/4" x 10 mm	1	47	517.0809	Double ring spanner, offset, 14 x 15 mm	1				
40	503.4296	GEARplus socket adaptor, 1/4" x 10 mm	1	48	517.0810	Double ring spanner, offset, 16 x 17 mm	1				
				49	517.0812	Double ring spanner, offset, 18 x 19 mm	1				
				50	517.0813	Double ring spanner, offset, 20 x 22 mm	1				
				51	517.0300	Double revolving head spanner, 6 x 7 mm	1				
				52	517.0301	Double revolving head spanner, 8 x 9 mm	1				

813.0054

L Screw spanner set

319,^{EUR}—

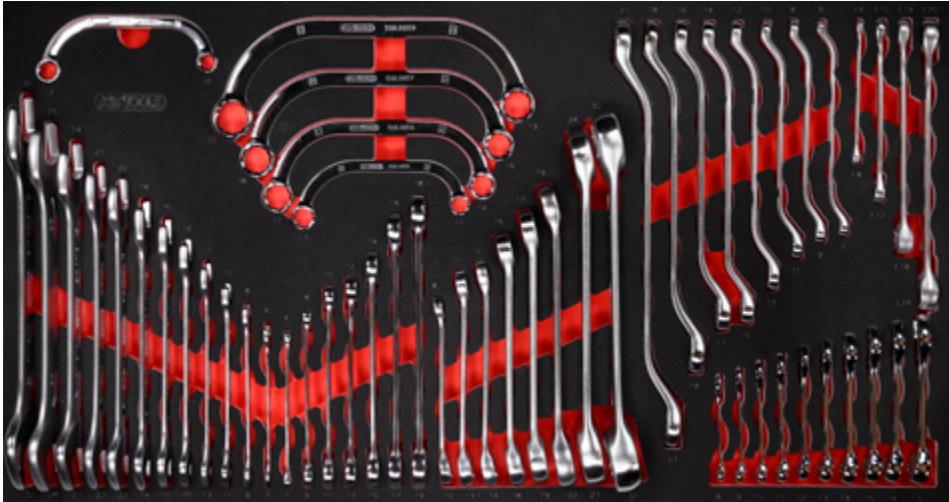

IPCS
54

755 x 398
P25

Pos.	Code	Description	pcs
1	518.0852	CHROMEplus Starter and block spanner, 10 x 12 mm	1
2	518.0859	CHROMEplus Starter and block spanner, 19 x 22 mm	1
3	518.0857	CHROMEplus Starter and block spanner, 16 x 18 mm	1
4	518.0856	CHROMEplus Starter and block spanner, 14 x 17 mm	1
5	518.0853	CHROMEplus Starter and block spanner, 11 x 13 mm	1
6	517.0718	Double open ended spanners, 30 x 32 mm	1
7	517.0737	Double open ended spanners, 25 x 28 mm	1
8	517.0716	Double open ended spanners, 24 x 27 mm	1
9	517.0715	Double open ended spanners, 21 x 23 mm	1
10	517.0714	Double open ended spanners, 20 x 22 mm	1

Pos.	Code	Description	pcs
11	517.0712	Double open ended spanners, 18 x 19 mm	1
12	517.0710	Double open ended spanners, 16 x 17 mm	1
13	517.0709	Double open ended spanners, 14 x 15 mm	1
14	517.0707	Double open ended spanners, 12 x 13 mm	1
15	517.0704	Double open ended spanners, 10 x 11 mm	1
16	517.0702	Double open ended spanners, 8 x 9 mm	1
17	517.0701	Double open ended spanners, 6 x 7 mm	1
18	920.0406	ULTIMATEplus Double ring ended spanner, 6 x 7 mm	1
19	920.0408	ULTIMATEplus Double ring ended spanner, 8 x 9 mm	1
20	920.0410	ULTIMATEplus Double ring ended spanner, 10 x 11 mm	1
21	920.0412	ULTIMATEplus Double ring ended spanner, 12 x 13 mm	1

Pos.	Code	Description	pcs
22	920.0414	ULTIMATEplus Double ring ended spanner, 14 x 15 mm	1
23	920.0416	ULTIMATEplus Double ring ended spanner, 16 x 17 mm	1
24	920.0418	ULTIMATEplus Double ring ended spanner, 18 x 19 mm	1
25	517.0252	Open double ring spanner, offset, 8 x 10 mm	1
26	517.9244	Open double ring spanner, offset, 11 x 13 mm	1
27	517.0258	Open double ring spanner, offset, 12 x 14 mm	1
28	517.0263	Open double ring spanner, offset, 16 x 18 mm	1
29	517.0264	Open double ring spanner, offset, 17 x 19 mm	1
30	517.0266	Open double ring spanner, offset, 19 x 22 mm	1
31	517.0268	Open double ring spanner, offset, 24 x 27 mm	1
32	517.0269	Open double ring spanner, offset, 30 x 32 mm	1

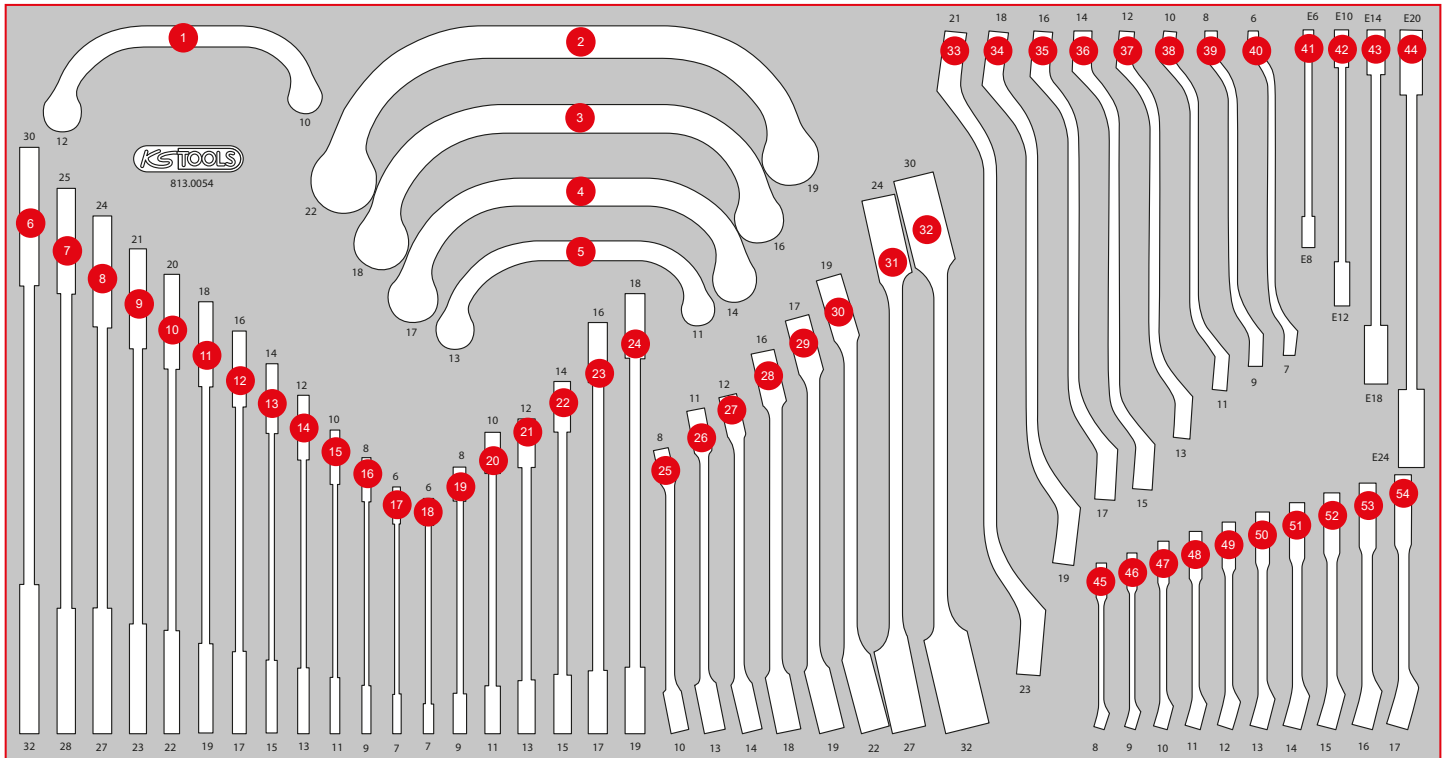

Pos.	Code	Description	pcs	Pos.	Code	Description	pcs	Pos.	Code	Description	pcs
33	517.0815	Double ring spanner, offset, 21 x 23 mm	1	44	911.0376	Double ring spanner for Torx E profile, E20 x E24	1	51	518.0014	CHROMEplus Combination spanner, stubby, 14 mm	1
34	517.0812	Double ring spanner, offset, 18 x 19 mm	1	45	518.0007	CHROMEplus Combination spanner, stubby, 8 mm	1	52	518.0015	CHROMEplus Combination spanner, stubby, 15 mm	1
35	517.0810	Double ring spanner, offset, 16 x 17 mm	1	46	518.0008	CHROMEplus Combination spanner, stubby, 9 mm	1	53	518.0016	CHROMEplus Combination spanner, stubby, 16 mm	1
36	517.0809	Double ring spanner, offset, 14 x 15 mm	1	47	518.0010	CHROMEplus Combination spanner, stubby, 10 mm	1	54	518.0017	CHROMEplus Combination spanner, stubby, 17 mm	1
37	517.0807	Double ring spanner, offset, 12 x 13 mm	1	48	518.0011	CHROMEplus Combination spanner, stubby, 11 mm	1				
38	517.0804	Double ring spanner, offset, 10 x 11 mm	1	49	518.0012	CHROMEplus Combination spanner, stubby, 12 mm	1				
39	517.0802	Double ring spanner, offset, 8 x 9 mm	1	50	518.0013	CHROMEplus Combination spanner, stubby, 13 mm	1				
40	517.0801	Double ring spanner, offset, 6 x 7 mm	1								
41	911.0371	Double ring spanner for Torx E profile, E6 x E8	1								
42	911.0373	Double ring spanner for Torx E profile, E10 x E12	1								
43	911.0374	Double ring spanner for Torx E profile, E14 x E18	1								

813.0042

L Screwdriver and file set

229, ^{EUR}-

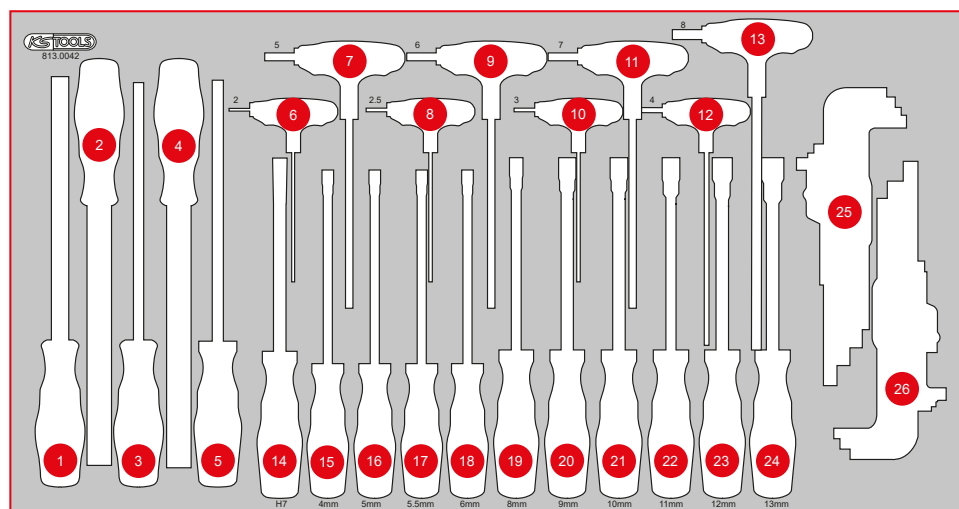
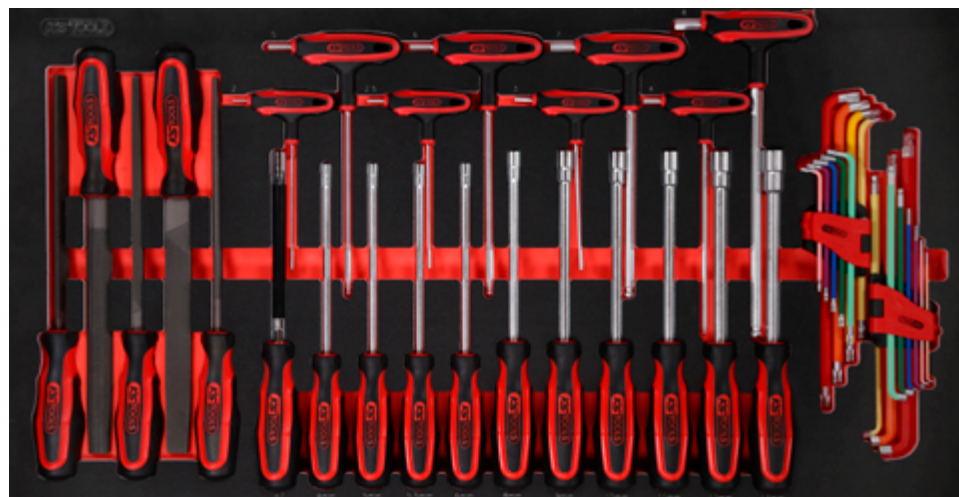

Pos.	Code	Description	pcs
1	157.0405	Tri-bastard file, form C, cut 2, 200 mm	1
2	157.0105	Halfround file, form E, cut 2, 20 mm	1
3	157.0305	Square file, form D, cut2, 200mm	1
4	157.0005	Flat file, form B, cut 2, 200 mm	1
5	157.0205	Round file, form F, cut 2, 200 mm	1
6	151.8130	T-handle ball ended hexagon key wrench, 2 mm	1
7	151.8134	T-handle ball ended hexagon key wrench, 5 mm	1
8	151.8131	T-handle ball ended hexagon key wrench, 2,5 mm	1
9	151.8135	T-handle ball ended hexagon key wrench, 6 mm	1
10	151.8132	T-handle ball ended hexagon key wrench, 3 mm	1
11	151.8136	T-handle ball ended hexagon key wrench, 7 mm	1
12	151.8133	T-handle ball ended hexagon key wrench, 4 mm	1
13	151.8137	T-handle ball ended hexagon key wrench, 8 mm	1
14	159.1127	ERGOTORQUEplus Socket screwdriver, 7 mm	1
15	159.1201	ERGOTORQUEplus Socket screwdriver, 4 mm	1
16	159.1202	ERGOTORQUEplus Socket screwdriver, 5 mm	9
17	159.1203	ERGOTORQUEplus Socket screwdriver, 5,5 mm	9
18	159.1204	ERGOTORQUEplus Socket screwdriver, 6 mm	1
19	159.1206	ERGOTORQUEplus Socket screwdriver, 8 mm	1
20	159.1207	ERGOTORQUEplus Socket screwdriver, 9 mm	1
21	159.1208	ERGOTORQUEplus Socket screwdriver, 10 mm	1
22	159.1209	ERGOTORQUEplus Socket screwdriver, 11 mm	1
23	159.1210	ERGOTORQUEplus Socket screwdriver, 12 mm	1
24	159.1211	ERGOTORQUEplus Socket screwdriver, 13 mm	1
25	151.4530	Ball ended Torx key wrench set, extra long and bent 108°, 9 pcs	1
26	151.4420	Ball ended hexagon key wrench set, extra long, 9 pcs	1

813.0030

L Pliers and measuring tool set

359, — EUR



755 x 398

P25

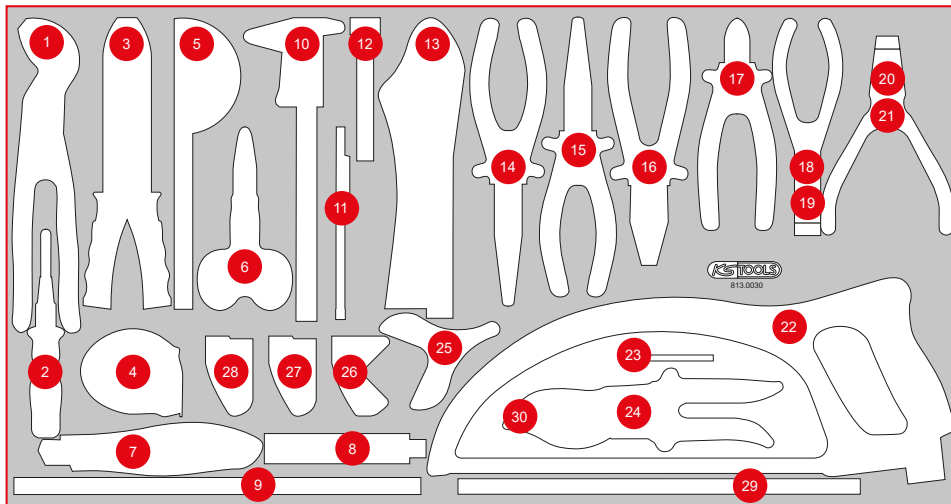

Pos.	Code	Description	pcs
1	115.2010	Water pump pliers, 240 mm	1
2	156.0466	Automatic centre punch, Ø 4 mm	1
3	115.1231	Multifunction pliers for insulated and non insulated cable terminals, 220 mm	1
4	300.0114	Tape measure with locking device and belt clip, black red, 5 m, 19 mm	1
5	300.0700	Protractor with rule, 220mm	1
6	118.0013	Uni workshop scissors, 143 mm	1
7	907.2135	Universal snap off blade knife 18 mm	1
8	907.2166	Snap off blades 0,5 x1 8 x 100 mm, dispenser 10 with 10 pieces	10
9	300.0104	Flexible steel rule, 300 mm	1
10	300.0510	Pocket vernier calliper 0-150 mm, 235 mm	1
11	550.1023	2in1 Telescopic solenoid lifter with washer jet cleaning and setting tool, 150-590mm	1
12	300.0600	Feeler gauge, 20 Blades, 0,05 - 1 mm	1
13	115.1033	Self grip wrench, 220 mm	1
14	115.1024	ERGOTORQUE long nose pliers serrated cutter, 200 mm	1
15	115.1019	ERGOTORQUE bent nose pliers serrated, 210 mm	1
16	115.1021	ERGOTORQUE combination pliers, 180 mm	1
17	115.1012	ERGOTORQUE diagonal side cutter, 160 mm	1
18	500.1032	Circlip pliers for internal circlips, angled, 160 mm	1
19	500.1035	Circlip pliers for internal circlips, 160 mm	1
20	500.1026	Circlip pliers for external circlips, angled, 160 mm	1
21	500.1029	Circlip pliers for external circlips, 160 mm	1
22	907.2115	Hacksaw frame, 300 mm	1
23	151.2604	Hexagon key wrench phosphate finish, short, 4mm	1
24	123.0076	Scissor-shaped with blades	1
25	123.0086	angular stop	1
26	123.0079	prism for 90° profile	1
27	123.0078	fitting for Ø 25 mm	1
28	123.0077	fitting for Ø 16 and 19 mm	1
29	129.6620-24	HSS Bi Co 8 metal high performance saw blades 1,0mm	1
30	123.0084	straight fitting	1

813.0040

L Hammer, chisel and impact socket set

299,-^{EUR}

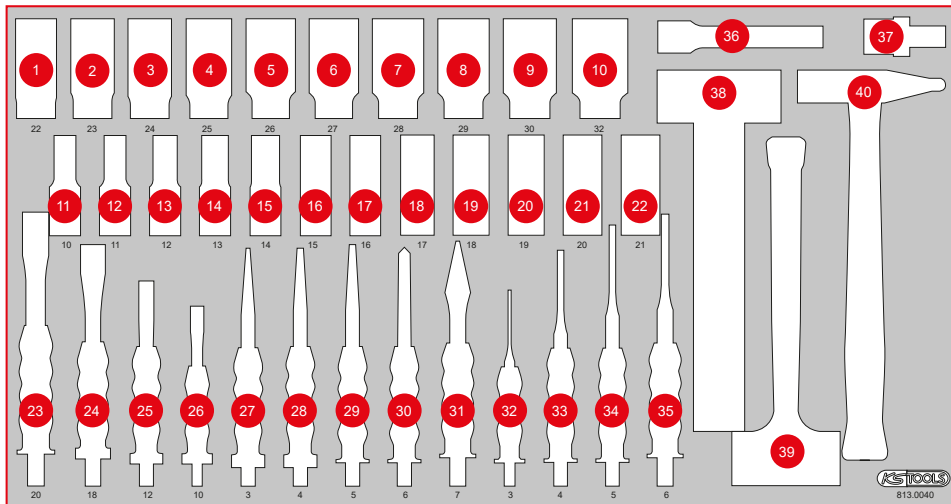

Pos.	Code	Description	pcs
1	515.1122	1/2" Hexagon impact socket, deep, 22 mm	1
2	515.1123	1/2" Hexagon impact socket, deep, 23 mm	1
3	515.1124	1/2" Hexagon impact socket, deep, 24 mm	1
4	515.1125	1/2" Hexagon impact socket, deep, 25 mm	1
5	515.1126	1/2" Hexagon impact socket, deep, 26 mm	1
6	515.1127	1/2" Hexagon impact socket, deep, 27 mm	1
7	515.1128	1/2" Hexagon impact socket, deep, 28 mm	1
8	515.1129	1/2" Hexagon impact socket, deep, 29 mm	1
9	515.1130	1/2" Hexagon impact socket, deep, 30 mm	1
10	515.1132	1/2" Hexagon impact socket, deep, 32 mm	1
11	515.1110	1/2" Hexagon impact socket, deep, 10 mm	1
12	515.1111	1/2" Hexagon impact socket, deep, 11 mm	1
13	515.1112	1/2" Hexagon impact socket, deep, 12 mm	1
14	515.1113	1/2" Hexagon impact socket, deep, 13 mm	1
15	515.1114	1/2" Hexagon impact socket, deep, 14 mm	1
16	515.1115	1/2" Hexagon impact socket, deep, 15 mm	1
17	515.1116	1/2" Hexagon impact socket, deep, 16 mm	1
18	515.1117	1/2" Hexagon impact socket, deep, 17 mm	1
19	515.1118	1/2" Hexagon impact socket, deep, 18 mm	1
20	515.1119	1/2" Hexagon impact socket, deep, 19 mm	1
21	515.1120	1/2" Hexagon impact socket, deep, 20 mm	1
22	515.1121	1/2" Hexagon impact socket, deep, 21 mm	1
23	156.0241	Flat chisel, octagon, 20 mm	1
24	156.0254	Flat chisel, octagon, 18 mm	1
25	156.0252	Flat chisel, octagon, 12 mm	1
26	156.0251	Flat chisel, octagon, 10 mm	1
27	156.0237	Punch, Ø 3 mm, conical	1
28	156.0238	Punch, Ø 4 mm, conical	1
29	156.0244	Punch, Ø 5 mm, conical	1
30	156.0243	Centre punch, octagon 10 mm	1
31	156.0242	Cross chisel, octagon, 7 mm	1
32	156.0231	Pin punch, Ø 3 mm, cylindrical shaft	1
33	156.0232	Pin punch, Ø 4 mm, cylindrical shaft	1
34	156.0233	Pin punch, Ø 5 mm, cylindrical shaft	1
35	156.0234	Pin punch, Ø 6 mm, cylindrical shaft	1
36	515.1135	1/2" Impact extension, 125 mm	1
37	515.1133	1/2" Impact universal ball joint	1
38	142.5101	Club hammer, fibreglas handle, 1000 g	1
39	140.5252	Recoil free soft faced hammer, 400 g	1
40	142.1402	Fitters hammer, fibreglas handle, 400 g	1

