

SUMMARY

REVIEW OF THE MANUAL.....	7
INTRODUCTION.....	8
1 GENERAL SAFETY REGULATIONS.....	9
1.1 Glossary.....	9
1.2 Operator Safety Regulations.....	9
1.2.1 General Safety Regulations.....	9
1.2.2 Risk of Asphyxiation.....	9
1.2.3 Risk of Impact and Crushing.....	9
1.2.4 Hazards Caused by Moving Parts.....	10
1.2.5 Risk of Burning or Scalding.....	10
1.2.6 Fire and Explosion Hazard.....	11
1.2.7 Noise Hazard.....	11
1.2.8 High Voltage Hazard.....	11
1.2.9 Poisoning Hazard.....	12
1.3 General User and Maintenance Warnings.....	12
2 KONFORT 700R SERIES USER SAFETY.....	13
2.1 Glossary.....	13
2.2 General Rules.....	14
2.3 Operator Safety.....	14
2.4 Device Safety.....	14
2.4.1 Safety Devices.....	15
2.5 Safety Precautions to follow when using the Refrigerants.....	16
2.6 Workplace Safety.....	16
2.7 Guidelines for the Handling of the Refrigerants Used.....	16
2.7.1 Refrigerant Storing Precautions.....	16
2.7.2 Refrigerant and System Conditions.....	17
2.7.3 Recycling Capacity.....	17
2.7.4 In General.....	17
3 NORMATIVE INFORMATION.....	18
4 OPERATION OF THE RADIO DEVICES.....	20
5 KONFORT 700R SERIES RECHARGING STATIONS.....	21

5.1	KONFORT 705R.....	23
5.2	KONFORT 705R OFF ROAD.....	24
5.3	KONFORT 707R.....	25
5.4	KONFORT 710R / 710L.....	26
5.5	KONFORT 712R.....	27
5.6	KONFORT 720R.....	28
5.7	KONFORT 760R.....	29
5.8	KONFORT 760R BUS.....	30
5.9	KONFORT 780R BI-GAS.....	31
6	DESCRIPTION OF 720R / 760R / 760R BUS / 780R BI-GAS.....	32
6.1	Front view.....	32
6.1.1	Control panel/display and top panel.....	33
6.2	Right Side View.....	34
6.3	Rear view.....	35
6.3.1	Containers.....	35
6.4	Left Side View.....	36
7	DESCRIPTION OF KONFORT 705R / 705R OFF ROAD / 707R / 710R / 710L / 712R.....	37
7.1	Front view.....	37
7.1.1	Control panel/display and top panel.....	39
7.2	Right Side View.....	41
7.3	Rear view.....	43
7.3.1	Standard Bottles.....	44
7.4	Left Side View.....	45
8	INSTALLATION.....	46
8.1	Unwrapping the Device.....	47
8.2	GAS KIT installation.....	47
9	SETTING UP BEFORE USING.....	49
9.1	Scale Locking/unlocking.....	49
9.2	Moving the Device.....	50
9.3	Positioning.....	50
9.4	Connection to the Power Mains.....	50
9.5	Entering the SD CARD.....	51

9.6	How to Load the Paper into the Printer.....	51
9.7	How to Fill the Bottles.....	52
9.7.1	Air-tight containers.....	52
9.7.2	Standard Bottles.....	53
9.8	How to Fill the Internal Tank.....	53
9.9	Language Setup.....	53
10	START-UP.....	55
10.1	Switching on.....	55
10.2	Activation.....	55
11	User Instructions.....	56
11.1	How to Connect to the Vehicle Air Conditioning System.....	56
11.2	Visual Warnings.....	56
11.3	Audible Warnings.....	56
11.4	How to Use the Software	57
11.5	Printer.....	58
12	STOP.....	59
12.1	Normal Stop.....	59
12.2	Stopping the Equipment for Long Periods.....	59
13	UPDATING.....	60
14	MAINTENANCE.....	62
14.1	Ordinary Maintenance.....	62
14.1.1	Dryer Filter Replacement.....	64
14.1.2	Mechanical Filter Replacement.....	66
14.1.3	How to Replace the Vaccum Pump Oil.....	67
14.1.4	Replacing the Paper in the Printer.....	69
14.2	Periodical Checks.....	69
14.3	Periodical Safety Checks.....	69
15	DISPOSAL.....	70
15.1	How to Dispose of the Device.....	70
15.2	How to Dispose of the Recycled Materials.....	70
16	DATA PLATE.....	71
17	KONFORT 720R / 760R / 760R BUS / 780R BI-GAS TECHNICAL FEATURES.....	72

18	KONFORT 710R / 710L / 712R TECHNICAL FEATURES.....	75
19	KONFORT 705R / 705R OFF ROAD / 707R / 710R / 710L TECHNICAL FEATURES.....	77
20	FLOW DIAGRAMS.....	79
21	LEGAL NOTICES.....	86

KONFORT 700R RECHARGING AND MAINTENANCE STATIONS TECHNICAL MANUAL

REVIEW OF THE MANUAL

This document is **review 12** of the **technical manual for the KONFORT Series 700R charging stations**.

Issue date: 18/03/2019

INTRODUCTION

Dear Customer,

We would like to thank you for choosing a TEXA product for your workshop.

We are certain that you will get the greatest satisfaction from it and receive a great deal of help in your work.

Please read through the instructions in this manual carefully and keep it for future reference.

Reading and understanding the following manual will help you to avoid damage or personal injury caused by improper use of the product to which it refers.

TEXA S.p.A reserves the right to make any changes deemed necessary to improve the manual for any technical or marketing requirement; the company may do so at any time without prior notice.

This product is intended for use by technicians specialized in the automotive field only. Reading and understanding the information in this manual cannot replace adequate specialized training in this field.

The sole purpose of the manual is to illustrate the operation of the product sold. It is not intended to offer technical training of any kind and technicians will therefore carry out any interventions under their own responsibility and will be accountable for any damage or personal injury caused by negligence, carelessness, or inexperience, regardless of the fact that a TEXA S.p.A. tool has been used based on the information within this manual.

Any additions to this manual, useful in describing the new versions of the program and new functions associated to it, may be sent to you through our TEXA technical bulletin service.

This manual should be considered an integral part of the product to which it refers. In the case it is resold the original buyer is therefore required to forward the manual to the new owner.

Reproduction, whole or in part, of this manual in any form whatsoever without written authorization from the producer is strictly forbidden.

The original manual was written in Italian, every other language is a translation of the original manual.

© **copyright and database rights 2017**. The material contained in this publication is protected by copyright and database rights. All rights are reserved by law and under International Conventions.

1 GENERAL SAFETY REGULATIONS

1.1 Glossary

- **Operator:** *qualified individual, in charge of using the device/tool.*
- **Machine/device/tool:** *the product purchased.*
- **Workplace:** *the place where the operator must carry out her/his work.*

1.2 Operator Safety Regulations

1.2.1 General Safety Regulations

- *The operator must be completely clear-headed and sober when using the device; taking drugs or alcohol before or when operating the device is strictly forbidden.*
- *The operator must not smoke during device operation.*
- *The operator must carefully read all the information and instructions in the technical documents provided with the device.*
- *The operator must follow all the instructions provided in the technical documents.*
- *The operator must always watch over the device during the various operating phases.*
- *The operator must make sure she/he is working in environment which is suitable for the operations that must be carried out.*
- *The operator must report any faults or potentially hazardous situation in connection with the workplace or the device.*
- *The operator must carefully follow the safety regulations required for the workplace in which she/he is working and required by the operations she/he has been asked to carry out.*

1.2.2 Risk of Asphyxiation

	<p>Exhaust gas from internal combustion engines, whether they may be petrol or diesel, are hazardous to your health and can cause serious harm to your body.</p>
---	--

Safety Precautions:

- *The workplace must be equipped with an adequate ventilation and air extraction system and must be in compliance with standards according to current national laws.*
- *Always activate the air extraction system when working in closed environments.*

1.2.3 Risk of Impact and Crushing

	<p>The vehicles which are undergoing A/C system recharging operations and the devices, must be properly blocked using the specific mechanical brakes/blocks, while being service.</p>
---	---

Safety Precautions:

- *Always make sure that the vehicle is in neutral gear (or that it is set in parking position in case of a vehicle equipped with automatic transmission).*
- *Always activate the hand brake or parking brake on the vehicle.*
- *Always block the wheels on the vehicle with the specific mechanical blocks.*
- *Make sure the device is stable, on a flat surface and the wheels are locked with the specific brakes.*



1.2.4 Hazards Caused by Moving Parts

	Vehicle engines include parts that move, both while running and not running (eg: the cooling fan is controlled by a thermal switch in connection with the coolant temperature and become activated even when the vehicle is off), that can injure the operator.
---	---

Safety Precautions:

- *Keep hands away from moving parts.*
- *Disconnect the engine cooling fan each time the engine you are working on is still hot. This will avoid the fan from becoming activated unexpectedly even when the engine is off.*
- *Do not wear ties, loose clothes, wrist jewellery or watches when working on a vehicle.*
- *Keep connection cables, probes and similar devices away from the moving parts of the engine.*

1.2.5 Risk of Burning or Scalding

 	The parts that are exposed to high temperatures in engines that are moving or have just stopped could burn the operator. Remember that catalytic mufflers reach very high temperatures, able to cause serious burns or even start fires. Acid in the vehicle batteries is another potential hazard.
--	---

Safety Precautions:

- *Protect your face, hands, and feet by using suitable protection.*
- *Avoid contact with hot surfaces, such as spark plugs, exhaust pipes, radiators and connections within the cooling system.*
- *Make sure there are no oil stains, rags, paper or other inflammable material near the muffler.*
- *Avoid splashing electrolyte on skin, eyes and clothes, as it is a corrosive and highly toxic compound.*

1.2.6 Fire and Explosion Hazard

	<p>The following are potential fires and/or explosion hazards:</p> <ul style="list-style-type: none"> • <i>The types of fuel used by the vehicle and the vapours released by these fuels.</i> • <i>The refrigerants used by the A/C system.</i> • <i>The acid in the vehicle batteries.</i>
---	--

Safety Precautions:

- *Let the engine cool.*
- *Do NOT smoke near the vehicle.*
- *Do NOT expose the vehicle to open flames.*
- *Make sure that the electrical connections are all well insulated.*
- *Collect any fuel that might have spilled.*
- *Collect any refrigerant that might have spilled.*
- *Make sure you are always working in an environment equipped with a good ventilation and air extraction system.*
- *Always activate the air extraction system when working in closed environments.*
- *Cover the openings of the batteries with a wet cloth in order to stifle the explosive gases before proceeding in testing or recharging.*
- *Avoid causing sparks when connecting cables to the battery.*

1.2.7 Noise Hazard

	<p>Loud noises that may occur within the workplace, especially during service operations may damage the operator's hearing.</p>
---	---

Safety Precautions:

- *Protect your ears with suitable protective ear wear.*

1.2.8 High Voltage Hazard

	<p>The voltage supply from the mains that powers the devices in the workplace and the voltage within the vehicle starter system is a potential shock hazard to the operator.</p>
---	--

Safety Precautions:

- *Make sure the electrical system in the workplace is compliant to current national standards.*
- *Make sure the device being used is connected to ground.*
- *Cut off the power supply voltage before connecting or disconnecting cables.*
- *Do NOT touch the high voltage cables when the engine is on.*

- *Operate in conditions of insulation from ground.*
- *Work with dry hands only.*
- *Keep conductive liquids away from the engine while working.*
- *Never leave tools on the battery in order to avoid accidental contacts.*

1.2.9 Poisoning Hazard

	<p>The hoses used to extract the refrigerants can release toxic gases, dangerous to the operator if exposed to temperatures higher than 250 °C or in case of a fire.</p>
---	--

Safety Precautions:

- *Contact a doctor immediately should you inhale these gases.*
- *Use neoprene or PVC gloves when eliminating combustion deposits.*

1.3 General User and Maintenance Warnings

When using the device or carrying out scheduled maintenance (eg. fuse replacement) on the device, carefully follow the information provided below.

- *Do not remove or damage the labels/tags and the warnings on the device; do NOT in any case make them illegible.*
- *Do not remove, or block, any safety devices the device is equipped with.*
- *Only use original spare parts or spare parts approved by the manufacturer.*
- *Contact your retailer for any non-scheduled maintenance.*
- *Periodically check the electrical connections of the device, making sure they are in good condition and replacing any damaged cables.*
- *Check parts that are subject to wear periodically and replace if necessary.*
- *Do not open or disassemble the device.*

2 KONFORT 700R SERIES USER SAFETY

Technology used for the design and testing of the recharging stations, **KONFORT 700R series**, make them simple, reliable and safe.

Personnel in charge of using the recharging stations is required to follow the general safety regulations, use the **KONFORT 700R Series** recharging stations for their intended use only and carry out the maintenance as described in this manual.

2.1 Glossary

- **Equipment:** *any KONFORT recharging station in the 700R series.*
- **External cylinder:** *new cylinder for R134a or R1234yf refrigerant used to fill the internal tank.*
- **Cycle:** *the carrying out of single phases.*
- **Operating phases:** *the carrying out of a single operation of the device (ie. recycling).*
- **Incondensable gas:** *air accumulated during the vapour phase in the refrigerant, withdrawn from the A/C system or from the tanks.*
- **UV tracer injection:** *the introduction of UV tracer into the A/C system in order to check for leaks.*
- **Oil injection:** *the introduction of oil into the A/C system in order to restore the correct quantity recommended by the manufacturer.*
- **Operator:** *qualified individual, in charge of servicing air conditioning systems using the KONFORT 700R series recharging station.*
- **Recovery:** *the removal of the refrigerant from the A/C system and the subsequent storage in the internal tank, without the need for analysis or treatment.*
- **Refrigerant:** *coolant liquid (R134a or R1234yf).*
- **Recycling:** *reduction of the contaminants in the refrigerants used by separating the oil, by removing the incondensable gases and passing the refrigerant once (or multiple times) through elements that reduce the humidity and acidity, etc.*
- **Refilling:** *refrigerant charging phase; charges the A/C system with the quantity of refrigerant recommended by the manufacturer.*
- **Internal tank:** *tank for the storage of the refrigerant.*
- **A/C system:** *air conditioning or climate control system.*
- **Disposal of the devices:** *removal of the refrigerant destined to be stored in order to be disposed of later (destroyed or transferred to waste disposal plants).*
- **Vacuumping:** *the evacuation of incondensable gases and humidity from within the A/C system exclusively through a vacuum pump.*

2.2 General Rules

- The operator must have basic knowledge within the refrigeration field, refrigeration system, as well as knowledge of refrigerants and of the potential hazards that devices under extreme pressure can cause.
- The operator must have fully read and understood the information and the instructions described in the technical documentation provided with the device.

2.3 Operator Safety

	<p>The refrigerant liquids can cause blindness and other physical damage. Due to their low boiling temperature (approximately - 30 °C), the refrigerants can cause cold burns when they come into contact with the skin.</p>
---	--

Safety Measures:

- *The operator must avoid inhaling the vapours of the refrigerant liquids; use appropriate protection when required.*
- *The operator is required to wear adequate safety glasses and gloves, that prevent direct contact with the refrigerants.*

	<p>The equipment has been designed to be steady both when being moved and once it is positioned. However, you must pay attention while moving it.</p>
---	---

Safety Measures:

- *Do not tilt the equipment in any way.*
- *Do not step on the equipment.*
- *Do not hang loads that may compromise the stability of the equipment, causing it to tip over.*
- *Make sure the equipment is steadily positioned on the ground on its four wheels whenever it does not need to be moved.*
- *Avoid moving it on uneven surfaces.*

2.4 Device Safety

	<p>The equipment was designed in accordance with the regulations about pressure equipment and assemblies, evaluating and reducing the risk where present and making appropriate considerations. However, vibrations, pressure variations or excessive temperatures, especially if cyclic, should be avoided.</p>
---	--

Safety Measures:

- *During use, do not move out of the TS operating temperature range and do not exceed the PS maximum operating pressure (see plate on the device).*
- *Only use refrigerants R134a or R1234yf.*
- *Make sure you use the correct refrigerant for the model of the device you are using.*
- *Make sure you use the correct refrigerant for the vehicle you are working on.*
- *Connect the hoses correctly by following the colours indicated: Blue hose - LP connection, red hose - HP connection.*
- *Connect both hoses to the corresponding connections of the same group (both hoses connected to GAS1 group or both hoses to the GAS2 group).*
- *Make sure all the valves are closed before connecting the device to the A/C system or to an external cylinder.*
- *Make sure the operating phase has come to an end and the valves are closed before disconnecting the device; this should be done to avoid the refrigerant from spreading into the atmosphere.*
- *It is absolutely forbidden to modify the calibration of the safety valves and the control systems.*
- *Do not smoke near the device or during the operating phases.*
- *Do not use the device near open flames, sparks, hot surfaces: the refrigerant decomposes at high temperatures, letting off toxic chemical substances that are harmful to people and the environment.*
- *Do not expose the device to direct sunlight, rain and bad weather conditions.*
- *Disconnect the hoses with extreme caution; they may contain refrigerant under high pressure.*
- *Make sure the couplers are not open when the hoses are placed back around the service hose holder.*
- *Do not leave the device connected to the power supply if you do not intend to use it immediately.*
- *To move the device use the specific handle only and balance the station on its wheels.*
- *If storing the device for a long period of time, disconnect it from the power mains and put it in a safe place, where it is not exposed to outside weather conditions.*

2.4.1 Safety Devices

The **KONFORT 700R series** recharging stations are equipped with the following safety features:

- **Safety pressure switch:** *stops the compressor when the pressure reaches a cut-off level.*
- **Safety valve:** *opens completely in the event the PS value is reached.*
- **Main switch:** *allows you to cut off the power supply from the power mains in case of an emergency or in order to carry out maintenance.*

Tampering with the above mentioned safety devices of any kind is strictly forbidden.

2.5 Safety Precautions to follow when using the Refrigerants

	<p>Certain mixtures of air and R134a have proved to be flammable at high pressures.</p> <p>These mixtures are potentially hazardous and can cause fires and explosions, causing personal injuries and damage to objects.</p> <p>Further safety and medical information can be obtained from lubricant and refrigerant manufacturers.</p>
---	--

Safety Measures:

- *Do not use external tanks or other storage systems that have not been approved and/or that are not equipped with safety valves.*
- *Do not test the devices or the vehicle A/C system containing R134a with compressed air.*

	<p>The refrigerant R1234yf has been classified as inflammable.</p>
---	--

Safety Measures:

- *Consult the safety sheet of this refrigerant in order to store it correctly.*

2.6 Workplace Safety

	<p>The device is designed to work at a maximum altitude of 1000 m above sea level, with an operating temperature between 5 °C and 40 °C and a maximum humidity of 50% at 50 °C.</p>
---	---

Safety Measures:

- *Never, under any circumstance, use the device in an environment where there is risk of an explosion.*
- *Keep the device in environments with temperatures that do not exceed 50 °C.*
- *Only use the device in open or well-ventilated environments (at least 4 air changes per hour).*
- *Make sure the workplace is well-lit (average operating illuminance, for mechanic workshops and assembly on work benches for precision work, is 500-750-1000 lux).*

2.7 Guidelines for the Handling of the Refrigerants Used

2.7.1 Refrigerant Storing Precautions

The device has been designed and built to operate with R134a or R1234yf refrigerants only.

- *The refrigerant removed from the A/C system must be handled with care, in order to prevent the refrigerants from mixing or in any case reduce the risk of this happening.*
- *The cylinders used for refrigerant storing must be specific to each refrigerant in order to prevent the refrigerants from mixing.*
- *The cylinders must be perfectly clean and clearly labelled in order to identify the refrigerant contained within.*

2.7.2 Refrigerant and System Conditions

The installment procedures and the maintenance carried out during the operating life of the A/C system substantially affect the quality of the refrigerant. The understanding of these factors is essential in order to decide whether or not the refrigerant from a system should be recycled.

The systems that have not been properly maintained (not cleaned, not emptied correctly, etc.) can have high contamination levels, both in the refrigerant and in the oil.

If the history of the system is not known, the refrigerant recovered must at least be recycled before it is reused.

When the contamination level is not known, you may carry out some preliminary checks with the kit specifically for acidity and humidity measurements.

2.7.3 Recycling Capacity

The filtering systems of the device must be replaced regularly in order to guarantee device efficiency.

The recycling must always be carried out, even when tests do not show that they are required.

2.7.4 In General

Before carrying out the refrigerant refilling phase, the A/C system must be emptied and cleaned (a vacuum operation must be carried out).

Carry out all the procedures as described in this manual in order to guarantee that the A/C system is free of contamination.

Carry out the scheduled/regular maintenance on the device as required, especially after it has been used with a highly contaminated refrigerant: it is essential that the contamination from one operation is not passed on to the following one.

3 NORMATIVE INFORMATION

Declaration of Conformity

	<p>Texa S.p.A. hereby declares that this KONFORT charging station:</p> <ul style="list-style-type: none">• 705R• 705R OFF ROAD• 707R• 710R• 710L• 712R• 720R• 760R• 760R BUS• 780R BI-GAS <p>complies with the essential requirements and with all further provisions defined by the following directives:</p> <ul style="list-style-type: none">• <i>2014/68/EU</i>• <i>2014/30/EU</i>• <i>2006/42/EC</i>• <i>2014/35/EU</i>• <i>2011/65/EU</i>
---	--

A complete copy of the Declaration of Conformity can be obtained at

Texa S.p.A., Via 1 Maggio 9, 31050 Monastier di Treviso (TV), Italy

Antenna

This product has been designed and tested to operate with the antenna provided with it.

In order to guarantee compliance with the above-mentioned regulations, use the appliance only with the antenna provided or with another antenna authorized by Texa S.p.A.

	상호 또는 성명	TEXA S.p.A.
	기기 명칭	Air conditioner gas Recharger
	모델명	Konfort 710R
	인증번호	KCC-REM-TXA-Konfort710R
	제조연월	2013. 4.
	제조사/제조국가	TEXA S.p.A.

4 OPERATION OF THE RADIO DEVICES

Wireless connection with Bluetooth, WiFi and 3G / 4G technology

The wireless connectivity with the Bluetooth, WiFi and 3G / 4G technology is a technology that supplies a standard, reliable method to exchange information between different devices, using radio waves. Adding to the TEXA instruments, many more products use this technology, such as cellular phones, portable devices, Computers, printers, photo cameras, Pocket PCs etc.

The Bluetooth, WiFi and 3G / 4G interfaces look for compatible electronic devices according to the radio signal they emit and establish a connection between them. TEXA tools select and only prompt you with compatible TEXA devices. This does not exclude the presence of other sources of communication or disturbance.

THE EFFICIENCY AND THE QUALITY OF BLUETOOTH, WiFi AND 3G / 4G COMMUNICATION MAY BE INFLUENCED BY THE PRESENCE OF RADIO DISTURBANCE SOURCES. THE COMMUNICATION PROTOCOL HAS BEEN DEVELOPED TO MANAGE THESE TYPES OF ERRORS; HOWEVER, IN THESE CASES COMMUNICATION MAY BECOME DIFFICULT AND CONNECTION MAY REQUIRE SEVERAL ATTEMPTS.

SHOULD THE WIRELESS CONNECTION ENCOUNTER SERIOUS PROBLEMS THAT MAY COMPROMISE A REGULAR COMMUNICATION, THE SOURCE OF THE ENVIRONMENTAL ELECTROMAGNETIC INTERFERENCE MUST BE IDENTIFIED AND ITS INTENSITY REDUCED.

Position the tool so that the radio devices it is equipped with can work properly. In particular, do not cover it with any shielding or metallic materials in general.

5 KONFORT 700R SERIES RECHARGING STATIONS

The **KONFORT 700R Series** are devices that have been designed and developed to carry out maintenance on air conditioning and climate control systems on cars, trucks, buses and tractors.

The **KONFORT 700R Series** stations are high performance devices capable of carrying out the following operations in complete safety: recovery, recycling, vacuuming, oil injection, UV tracer injection, system refilling and efficiency checks on the A/C system.

The **Serie 700R** stations are equipped with a serial **SD CARD** containing the vehicle database.

The **SD CARD** allows you to automatically store the data of each service carried out.

The database update can be performed through the **SD CARD**.

The **700R Series** includes the following models:

- **705R**
- **705R OFF ROAD**
- **707R**
- **710R**
- **710L**
- **712R**
- **720R**
- **760R**
- **760R BUS**
- **780R BI-GAS**

The charging stations that can be purchased in the version that works with the **R134a** gas or with the **R1234yf** gas are:

- **712R**
- **720R**
- **760R**
- **760R BUS**

A kit containing specific fittings for the version purchased (**GAS KIT**) is provided along with these models.

The **GAS KIT** must be installed following the instructions described in the chapter **Installation**.

The stations purchased in the version that operates with the **R134a** refrigerant can be retrofitted at any time, so that it can operate with the new **R1234yf** refrigerant.

The modification requires the installation of a specific **RETROFIT KIT** (optional).

The charging stations that work with the **R134a** gas **only** are:

- **705R**
- **705R OFF ROAD**
- **710R**
- **710L**

The **RETROFIT KIT** is not available for these charging stations.

The charging stations that work with the **R1234yf** gas **only** are:

- **707R**

The **780R BI-GAS** recharging stations are designed, and already set up, to operate with both refrigerants.

These charging stations are not equipped with a **GAS KIT** as they are supplied already ready for use.

5.1 KONFORT 705R

The **KONFORT 705R** charging station is the base version of the **700R Series**.

KONFORT 705R can operate on cars, trucks, and tractors.

MAIN FEATURES

- *R134a compatible*
- *Graphic LED display 240x128 COG 4.8"*
- *DATABASE management and services carried out via SD CARD*
- *Pressure gauge unit*
- *10 kg tank*
- *Single stage vacuum pump*
- *High efficiency refrigerant recovery (over 95%)*
- *Automatic oil injection (timed operation)*
- *2 manual (turn wheel) valves for AC service hoses*
- *Operating mode:*
 - *DATABASE*
 - *CUSTOMIZED SERVICE*
 - *MY DATABASE*
- *Multilingual coverage of the software*
- *Service hoses automatic length offset*
- *Automatic maintenance warning*
- *Simplified maintenance*



5.2 KONFORT 705R OFF ROAD

The **KONFORT 705R OFF ROAD** charging station was developed starting from the 705R charging station in order to make it suitable for use on uneven or rough grounds.

KONFORT 705R can operate on cars, trucks, and tractors.

MAIN FEATURES

- *R134a compatible*
- *Graphic LED display 240x128 COG 4.8"*
- *DATABASE management and services carried out via SD CARD*
- *Pressure gauge unit*
- *10 kg tank*
- *Scale lock*
- *Single stage vacuum pump*
- *High efficiency refrigerant recovery (over 95%)*
- *Automatic oil injection (timed operation)*
- *2 manual (turn wheel) valves for AC service hoses*
- *Operating mode:*
 - *DATABASE*
 - *CUSTOMIZED SERVICE*
 - *MY DATABASE*
- *Multilingual coverage of the software*
- *Service hoses automatic length offset*
- *Automatic maintenance warning*
- *Simplified maintenance*



5.3 KONFORT 707R

The **KONFORT 707R** charging station is an advanced version of the **705R** charging station and is specific for the R1234yf refrigerant.

KONFORT 707R can operate on cars, trucks, and tractors.

MAIN FEATURES

- *R1234yf compatible*
- *Graphic LED display 240x128 COG 4.8"*
- *DATABASE management and services carried out via SD CARD*
- *Pressure gauge unit*
- *10 kg tank*
- *Single stage vacuum pump*
- *High efficiency refrigerant recovery (over 95%)*
- *Automatic oil injection (timed operation)*
- *Full automatic*
- *Incondensable gases automatic drain management*
- *Setup for the refrigerant identifier*
- *Band heater*
- *Operating mode:*
 - *DATABASE*
 - *CUSTOMIZED SERVICE*
 - *MY DATABASE*
- *Multilingual coverage of the software*
- *Service hoses automatic length offset*
- *Automatic maintenance warning*
- *Simplified maintenance*



5.4 KONFORT 710R / 710L

The **KONFORT 710R / 710L** charging stations are an advanced version of the **705R** charging station.

KONFORT 710R / 710L can operate on cars, trucks and tractors.

MAIN FEATURES

- *R134a compatible*
- *Graphic LED display 240x128 COG 4.8"*
- *DATABASE management and services carried out via SD CARD*
- *Pressure gauge unit*
- *Tank:*
 - *710R: 10 kg*
 - *710L: 20 kg*
- *Double stage vacuum pump*
- *High efficiency refrigerant recovery (over 95%)*
- *Automatic oil injection (timed operation)*
- *2 manual (turn wheel) valves for AC service hoses*
- *Band heater*
- *Operating mode:*
 - *DATABASE*
 - *CUSTOMIZED SERVICE*
 - *MY DATABASE*
- *Multilingual coverage of the software*
- *Service hoses automatic length offset*
- *Automatic maintenance warning*
- *Simplified maintenance*



5.5 KONFORT 712R

The **KONFORT 712R** charging stations are an advanced version of the **710R** charging station.

MAIN FEATURES



- *R134a or R1234yf compatible*
- *Graphic LED display 240x128 COG 4.8"*
- *DATABASE management and services carried out via SD CARD*
- *10 kg tank*
- *Double stage vacuum pump*
- *High efficiency refrigerant recovery (over 95%)*
- *High-precision automatic oil drain management*
- *Automatic oil injection (timed operation)*
- *Band heater*
- *Operating mode:*
 - *DATABASE*
 - *CUSTOMIZED SERVICE*
 - *MY DATABASE*
- *Multilingual coverage of the software*
- *Service hoses automatic length offset*
- *Automatic maintenance warning*
- *Simplified maintenance*
- *Incondensable gases automatic drain management*

5.6 KONFORT 720R

The **KONFORT 720R** charging station is the advanced version of the **710R** charging station.

KONFORT 720R can operate on cars, trucks, and tractors.

MAIN FEATURES



- *R134a or R1234yf compatible*
- *Graphic LED display 240x128 COG 4.8"*
- *DATABASE management and services carried out via SD CARD*
- *Rotating pressure gauge assembly-display (Germany not included)*
- *12 kg tank*
- *Double stage vacuum pump*
- *High efficiency refrigerant recovery (over 95%)*
- *Automatic oil injection (timed operation)*
- *2 manual (turn wheel) valves for AC service hoses*
- *Band heater*
- *Operating mode:*
 - *DATABASE*
 - *CUSTOMIZED SERVICE*
 - *MY DATABASE*
- *Multilingual coverage of the software*
- *Service hoses automatic length offset*
- *Automatic maintenance warning*
- *Simplified maintenance*
- *Incondensable gases automatic drain management*

5.7 KONFORT 760R

The **KONFORT 760R** recharging station has been designed and developed to meet the requirements of more demanding operators.

KONFORT 760R can operate on cars, trucks and tractors.

MAIN FEATURES



- *R134a or R1234yf compatible*
- *High visibility TFT colour display*
- *Advanced graphic interface*
- *DATABASE management and services carried out via SD CARD*
- *Rotating pressure gauge assembly-display (Germany not included)*
- *20 kg tank*
- *Double stage vacuum pump*
- *High efficiency refrigerant recovery (over 95%)*
- *Anti-contamination airtight oil bottles (patent pending)*
- *High precision automatic oil injection*
- *Automatic oil bottle recognition (patent pending)*
- *Automatic refrigerant accurate quantity control (patent pending)*
- *Scale locking system*
- *Automatic maintenance service management*
- *Band heater*
- *Operating mode:*
 - *DATABASE*
 - *CUSTOMIZED SERVICE*
 - *MY DATABASE*
- *Multilingual coverage of the software*
- *Service hoses automatic length offset*
- *Automatic maintenance warning*
- *Simplified maintenance*
- *Uncondensable gases automatic drain management*

5.8 KONFORT 760R BUS

The **KONFORT 760R BUS** recharging station has been specifically developed to operate within the "large climate control systems" sector.

KONFORT 760R BUS can operate on cars, trucks, tractors, buses, coaches and similar vehicles.

MAIN FEATURES



- *R134a or R1234yf compatible*
- *High visibility TFT colour display*
- *Advanced graphic interface*
- *DATABASE management and services carried out via SD CARD*
- *Rotating pressure gauge assembly-display (Germany not included)*
- *30 kg tank*
- *Double stage vacuum pump*
- *High efficiency refrigerant recovery (over 95%)*
- *Anti-contamination airtight oil bottles (patent pending)*
- *High precision automatic oil injection*
- *Automatic oil bottle recognition (patent pending)*
- *Automatic refrigerant accurate quantity control (patent pending)*
- *Scale locking system*
- *Automatic maintenance service management*
- *Band heater*
- *Operating mode:*
 - *DATABASE*
 - *CUSTOMIZED SERVICE*
 - *MY DATABASE*
- *Multilingual coverage of the software*
- *Service hoses automatic length offset*
- *Automatic maintenance warning*
- *Simplified maintenance*
- *Incondensable gases automatic drain management*

5.9 KONFORT 780R BI-GAS

The **KONFORT 780R BI-GAS** recharging station is the top of line within the **700R Series**.

KONFORT 780R can operate on cars, trucks, and tractors.

MAIN FEATURES



- *R134a and R1234yf refrigerant dual line management*
- *High visibility TFT colour display*
- *Advanced graphic interface*
- *DATABASE management and services carried out via SD CARD*
- *Rotating pressure gauge assembly-display (Germany not included)*
- *2 12 kg tanks*
- *Double stage vacuum pump*
- *High efficiency refrigerant recovery (over 95%)*
- *Anti-contamination airtight oil containers (patents pending)*
- *High precision automatic oil injection*
- *Automatic oil bottle recognition (patent pending)*
- *Automatic refrigerant accurate measurement control (patent pending)*
- *Scale locking system*
- *Automatic maintenance service management*
- *2 band heaters*
- *Operating mode:*
 - *DATABASE*
 - *CUSTOMIZED SERVICE*
 - *MY DATABASE*
- *Multilingual coverage of the software*
- *Service hoses automatic length offset*
- *Automatic maintenance warning*
- *Simplified maintenance*
- *Uncondensable gases automatic drain management*
- *Thermal printer*

6 DESCRIPTION OF 720R / 760R / 760R BUS / 780R BI-GAS

This chapter describes the general features of the charging stations:

- 720R
- 760R
- 760R BUS
- 780R BI-GAS

6.1 Front view



1. High pressure gauge (HP)
2. Low pressure gauge (LP)
3. Control panel/display
4. Top panel
5. Body of the recharging station
6. Cylinder compartment door
7. Scale locking / unlocking device *
8. Castors

(*) Not available on the charging station model 720R.

6.1.1 Control panel/display and top panel



1. Setup for the **Bluetooth** module
2. Setup for the **System Efficiency Check** module
3. Status LED:
 - **GAS - ORANGE/GREEN** - Type of refrigerant
 - **BLU** - Bluetooth
 - **REC - GREEN** - Recycling
 - **VAC - BLUE** - Vacuuming
 - **INJ - ORANGE** - Injection
 - **REF - RED** - Refilling
4. High visibility TFT colour display *
5. Printer **
6. Keypad

(*) The **720R** charging stations are equipped with a blue high visibility LCD 80 character display with backlighting.

(**) Supplied only with the charging station model **780R**.

KEYPAD

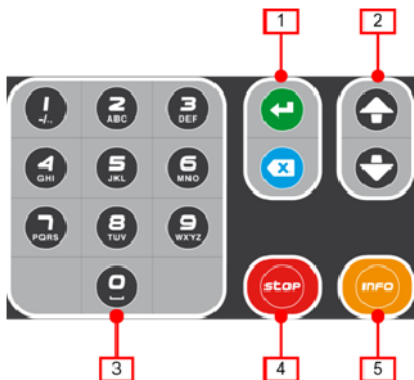

1. **ENTER** and **BACK/CANCEL** keys
2. **UP** and **DOWN** arrow keys
3. Alphanumerical keypad
4. **STOP** key
5. **INFO** key

PRINTER



1. Paper compartment lever
2. Paper compartment cover
3. Printer Status LED - **GREEN**
4. **PAPER ADVANCE** key
5. **ON/OFF** key

6.2 Right Side View

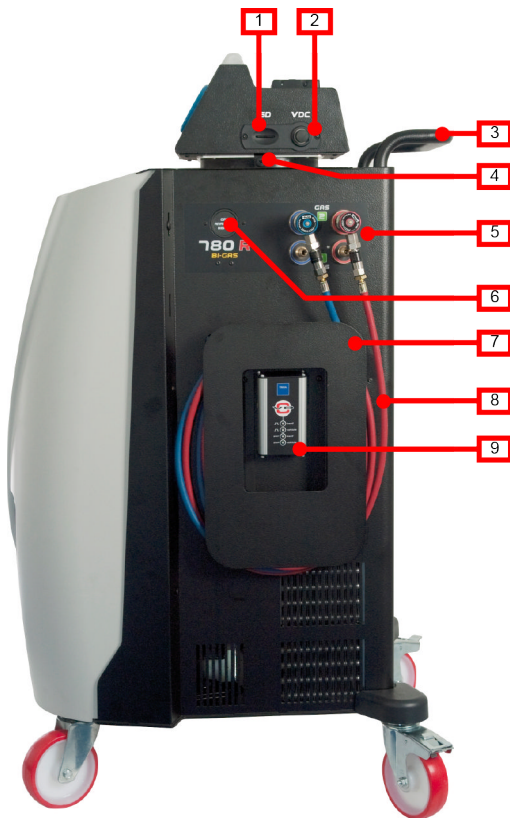

1. **SD CARD** slot
2. **VDC** connector
3. *Handle*
4. *Control panel/display fastening screw*
5. **HP/LP** quick fittings for the service hoses:
 - **GAS 1 HP/LP:** connections for R134a refrigerants*
 - **GAS 2 HP/LP:** connections for R1234yf refrigerants**
6. *Setup for the **Refrigerant Identifier** ****
7. *Service hose holder*
8. *Service hoses*
9. **VDC** housing

(*) Available on all the charging of the **Series 700R**.

(**) Available only on the charging station model **780R**.

(***) Not available only on the charging station model **720R**.

In the **720R** charging stations, the **HP/LP couplers** are positioned in the place of the **Refrigerant Identifier**.



6.3 Rear view

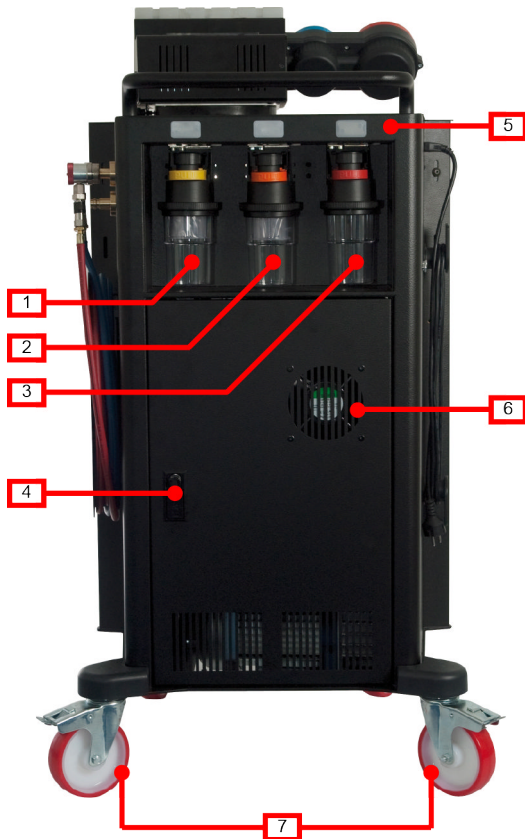

1. **OIL PAG/POE** air-tight bottle for specific oil *
2. **UV** air-tight bottle for the UV tracer *
3. **DRAIN** air-tight bottle to hold the recovered oil *
4. Service door
5. Bottle status LED **
 - **GREEN:** bottle inserted correctly
 - **RED:** bottle removed or not correctly inserted.
6. Cooling fan
7. Castors with brakes

(*) The **720R** charging stations are equipped with standard type bottles.

(**) Not available on the charging station model **720R**.

6.3.1 Containers

AIRTIGHT CONTAINERS

Available on the **760R**, **760R BUS**, and **780R** charging stations.



1. Bottle unlocking handle*
2. Cup fastening ring
3. Cup
4. Tank**
5. Tank cap
6. Pneumatic connection
7. Electronic connector

(*) The colour of the unlocking handle indicates what the bottle must be used for.

(**) not present in the bottle **DRAIN**

The colours correspond to the following uses:

- **Yellow:** PAG oil
- **Green:** POE oil
- **Orange:** UV tracer
- **Red:** recovered oil

STANDARD BOTTLES

Available on the **720R** charging stations.



1. *Pneumatic connection*
2. *Tank cap*
3. *Tank*

The standard bottles can be identified by their different capacity:

- **250 ml:** *PAG or POE oil*
- **250 ml:** *UV tracer*
- **500 ml:** *recovered oil*

6.4 *Left Side View*

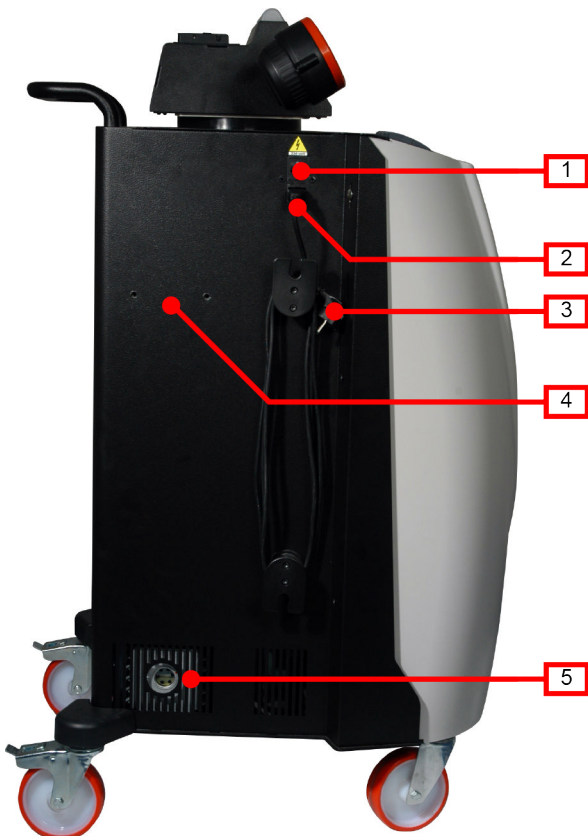

1. *Main switch*
2. *Power supply cable connector*
3. *Power supply cable*
4. *Fastening holes for the **FLUSHING KIT***
5. *Pump oil level inspection*

7 DESCRIPTION OF KONFORT 705R / 705R OFF ROAD / 707R / 710R / 710L / 712R

This chapter describes the general features of the charging stations:

- 705R
- 705R OFF ROAD
- 707R
- 710R
- 710L
- 712R

7.1 Front view

KONFORT 705R / 705R OFF ROAD



1. Dashboard *
2. Body of the recharging station
3. Based on the model:
 - **705R:** Castors with brakes
 - **705R OFF ROAD:** support stand

(*) The Control Unit is built-in.

KONFORT 707R



1. Dashboard *
2. Body of the recharging station
3. Castors with brakes

(*) The Control Unit is built-in.

KONFORT 710R / 710L / 712R



1. Dashboard *
 2. Body of the recharging station
 3. Cylinder compartment door
 4. Castors with brakes
- (*) The Control Unit is built-in.

7.1.1 Control panel/display and top panel

KONFORT 705R / 705R OFF ROAD



1. High Pressure gauge (HP)
2. Low Pressure gauge (LP)
3. Graphic LED display 240x128 COG 4.8"
4. LP and HP taps
5. Printer connection
6. Keyboard

KONFORT 707R

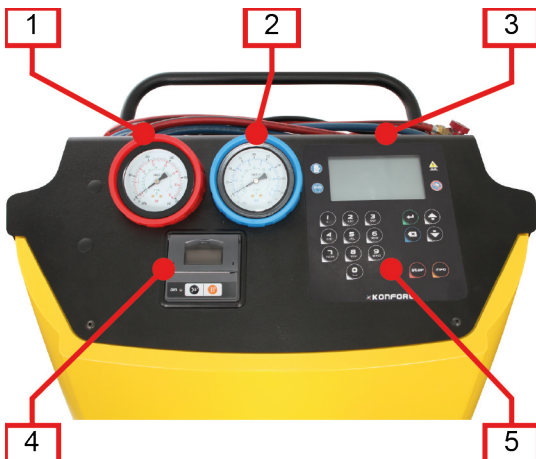

1. High Pressure gauge (HP)
2. Low Pressure gauge (LP)
3. Graphic LED display 240x128 COG 4.8"
4. Printer connection
5. Keyboard

KONFORT 710R / 710L / 712R



1. High Pressure gauge (HP)
2. Low Pressure gauge (LP)
3. Graphic LED display 240x128 COG 4.8"
4. Printer connection
5. Status LED
 - **REC - GREEN** - Recycling
 - **VAC - BLUE** - Vacuuming
 - **INJ - ORANGE** - Injection
 - **REF - RED** - Refilling
6. Keyboard

KEYPAD

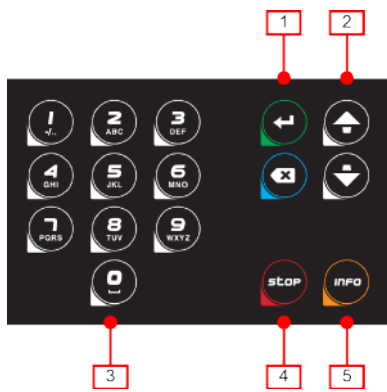

1. **ENTER** and **BACK/CANCEL** keys
2. **UP** and **DOWN** arrow keys
3. *Alphanumerical keypad*
4. **STOP** key
5. **INFO** key

7.2 Right Side View

KONFORT 705R

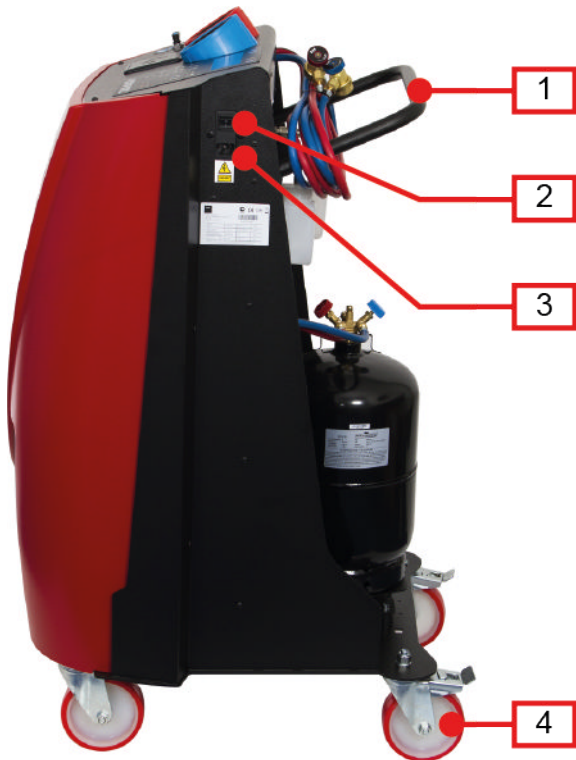

1. Handle
2. Main switch
3. Power supply cable connector
4. Castors with brakes

KONFORT 705R OFF ROAD



1. Handle
2. Main switch
3. Power supply cable connector
4. Oversized and puncture-proof wheels

KONFORT 707R



1. Handle
2. Main switch
3. Power supply cable connector
4. Castors with brakes

KONFORT 710R / 710L / 712R



1. Handle
 2. **SD CARD** slot
 3. **LP and HP*** taps
 4. Service hose holder
 5. Castors with brakes
- (* Except 712R)

7.3 Rear view

KONFORT 705R / 705R OFF ROAD

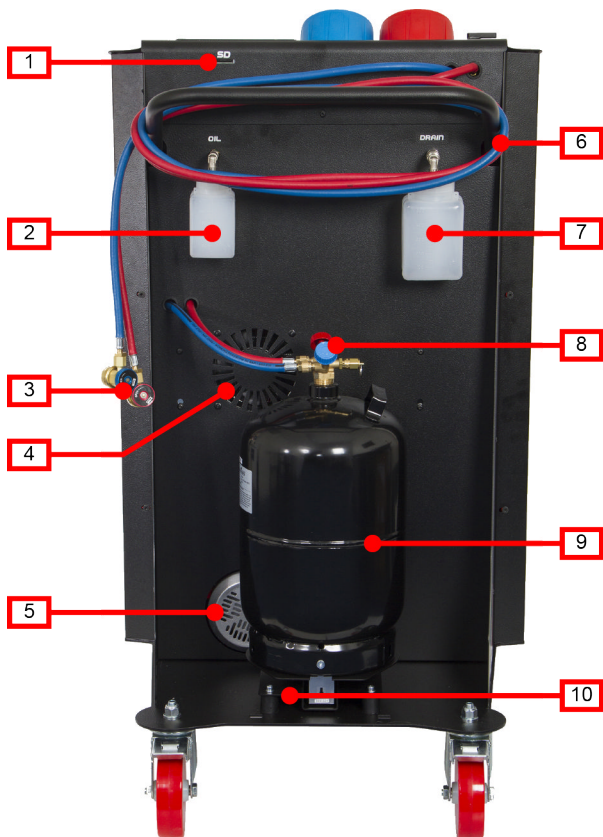

1. **SD CARD** slot
 2. Standard **OIL PAG/POE** bottle for specific oil
 3. **HP/LP** quick fittings for the service hoses
 4. Cooling fan
 5. Pump air vent
 6. Service hoses
 7. Standard **DRAIN** bottle to hold the recovered oil
 8. Vessel (gas and liquid) taps
 9. Tank
 10. Scale lock / unlock *
- (*) Only on the charging station model **705R OFF ROAD**.

KONFORT 707R

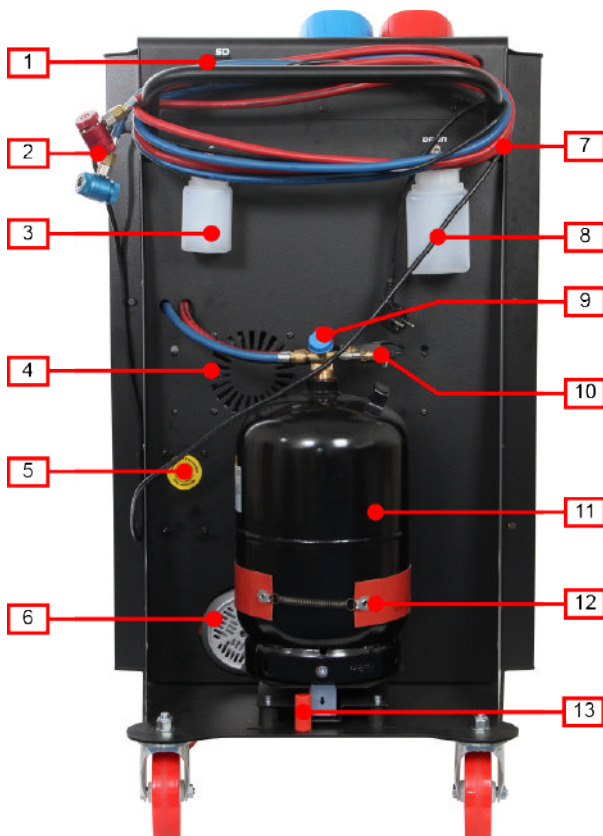

1. **SD CARD** slot
2. **HP/LP** quick fittings for the service hoses
3. Standard **OIL PAG/POE** bottle for specific oil
4. Cooling fan
5. Setup for the **Refrigerant Identifier**
6. Pump air vent
7. Service hoses
8. Standard **DRAIN** bottle to contain the recovered oil
9. Vessel (gas and liquid) closing taps
10. Automatic non-condensable drain with safety valve
11. Tank
12. Heating band
13. Scale lock / unlock

KONFORT K710R / 710L / 712R

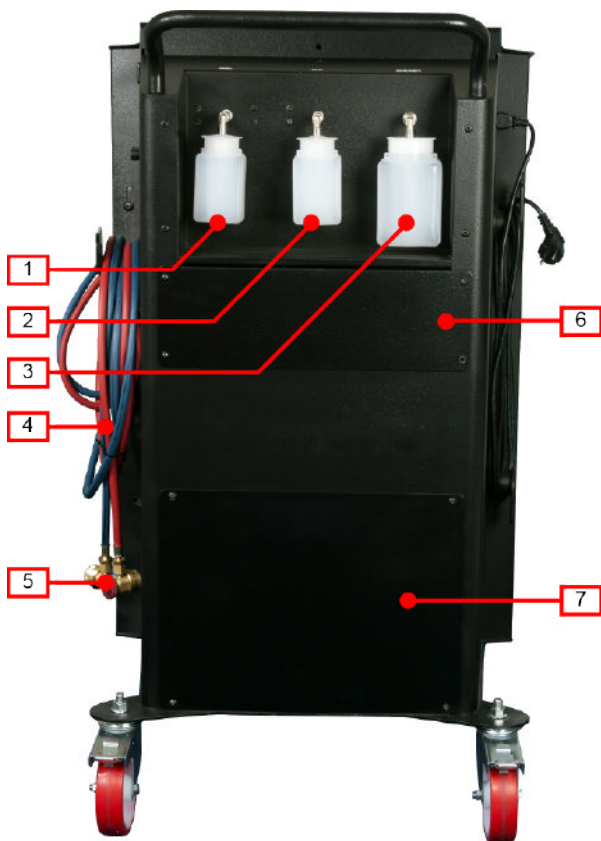

1. Standard **OIL PAG/POE** bottle for specific oil
2. Standard **UV** bottle for the UV tracer
3. Standard **DRAIN** bottle to hold the recovered oil
4. Service hoses
5. **HP/LP** quick fittings for the service hoses
6. Service bulkhead to access the filter
7. Service bulkhead to access the pump

7.3.1 Standard Bottles



1. Pneumatic connection
2. Tank cap
3. Tank

The standard bottles can be identified by their different capacity:

- **250 ml:** PAG or POE oil
- **250 ml:** UV tracer *
- **500 ml:** recovered oil

(*) Available only on the following charging stations:

- **710R**
- **710L**
- **712R**

7.4 Left Side View

KONFORT 705R / KONFORT 705R OFF ROAD / KONFORT 707R



KONFORT 710R / 710L / 712R

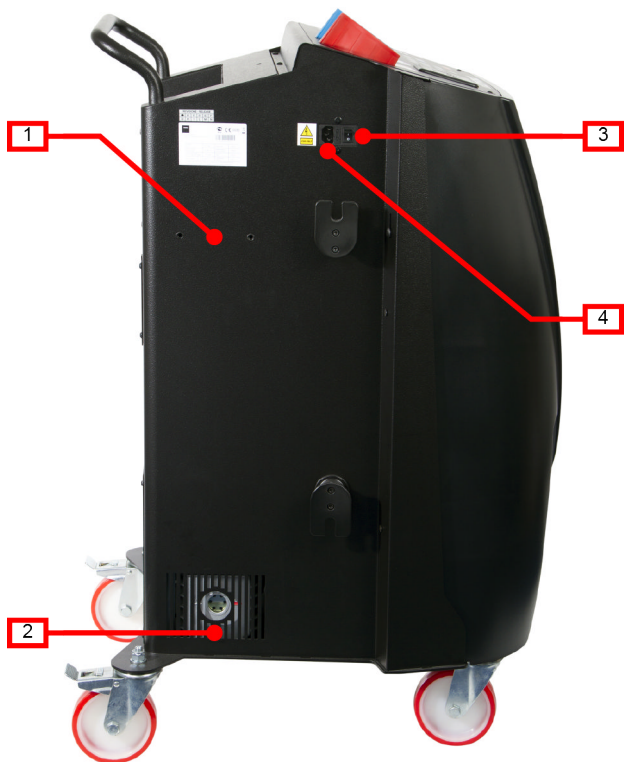

- 1. Fastening holes for the Flushing Kit
- 2. Pump oil level inspection
- 3. Main switch
- 4. Power supply cable connector

8 INSTALLATION

This chapter describes the procedures required in order to install the device properly.



The installation must be performed by qualified personnel only, carefully following the instructions provided in this manual.

The device is provided with the following:

- **GAS KIT** *:
 - *Connections for the quick fittings specific for the version purchased (R134a or R1234yf refrigerant)*
 - *Fastening screws for the fittings*
 - *Stickers that identify the fittings*
 - *Tag indicating the type of refrigerant used*
 - *Pressure clip used to fasten the tag*
- **Technical Manual**: *contains the description of the device, user instructions to guarantee a correct use and correct maintenance.*
- **CD Documentation**: *contains the technical and operating manual (user instructions for the device)*
- **SD CARD**
- **SD CARD READER**
- **Power supply cable**
- **Protective cover for the device**
- **TANK FILLING KIT**:
 - *Recharging cylinder hose adapter*
 - *Paper gasket for recharging cylinder hose adapter*
 - *Copper gasket for HP recharging cylinder hose adapter*

(*) *Not required for the charging stations:*

- **705R**
- **705R OFF ROAD**
- **707R**
- **710R**
- **710L**
- **780R BI-GAS**

8.1 Unwrapping the Device

This chapter describes the instructions for unwrapping/unpacking the device.



Perform the described operations with extreme care and on a flat surface in order to avoid the device from tipping over.

Proceed as follows:

1. Remove the **GAS KIT**.* **
2. Remove the cardboard.
3. Remove the bands that fasten the device to the pallet.
4. Remove the device from the pallet.
5. Unlock the wheels.
6. Make sure the device is in good condition and that it has not been tampered with and/or damaged.
7. Make sure no parts are missing.

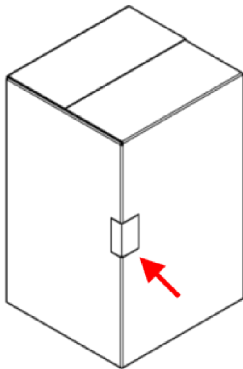

(*) *Not required for the charging station model **780R BI-GAS**.*

(**) *Already installed on the charging stations:*

- **705R**
- **705R OFF ROAD**
- **707R**
- **710R**
- **710L**

8.2 GAS KIT installation

This chapter describes the procedures that need to be carried out in order to install the GAS KIT.

The fittings of the kit have been designed so that they can only be installed on the mini manifolds they have been intended for.

Eg.: the HP quick fitting for the R134a refrigerant can only be installed on its specific manifold and not, for instance, on the LP mini manifold for the R1234yf refrigerant.

When installing the kit remember that:

- **RED:** *always indicates high pressure connection (HP)*
- **BLUE:** *always indicates low pressure connection (LP)*

The following operations are not required on the charging stations:



- 705R
- 705R OFF ROAD
- 707R
- 710R
- 710L
- 780R BI-GAS



Carry out the following operations with the equipment switched off and disconnected from the power mains.

Proceed as follows:

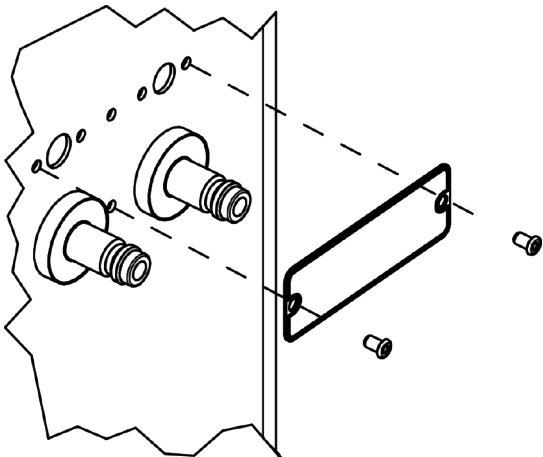
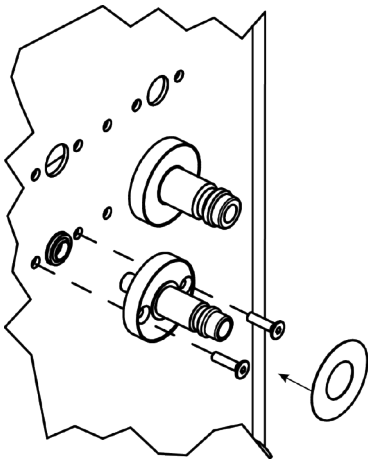

1. Go to the right hand side of the device.
2. Insert the connection for the **HP** quick hose fitting in the appropriate mini manifold.
3. Fasten the connection using the specific screws.
4. Attach the specific adhesive ring to the connection for the **HP** quick hose fitting.
5. Repeat the operations up to here for in order to install the connection for the **LP** quick hose fitting as well.
6. Place the tag indicating the gas type above the mini manifold. *
7. Fasten the tag using the specific pressure clips.
8. Pull the ferrule on the **HP** quick fitting slightly back and place it on the specific connection.
9. Screw on the ferrule.
10. Repeat the operations up to here for the **LP** quick fitting as well.

R-1234 YF

R134a

(*) The specific sticker indicating the type of gas used must be applied on the **712R** charging stations.

9 SETTING UP BEFORE USING

This chapter describes the maintenance operations required for setting up the equipment.

9.1 Scale Locking/unlocking

The equipment fitted with a locking system for the electronic refrigerant scale are:

- 705 OFF ROAD
- 707R
- 760R
- 760R BUS
- 780R BI-GAS



You must always lock the scale before moving the equipment.



You must always unlock the scale before using the equipment.

KONFORT 705R OFF ROAD / 707R

Proceed as follows:



1. Stand behind the equipment.
2. Locate the scale locking / unlocking control.
 - **Locking the scale:** *turn the locking/unlocking device counter-clockwise.*
 - **Unlocking the scale:** *turn the locking/unlocking device knob clockwise.*

KONFORT 760R / 760R BUS / 780R BI-GAS

Proceed as follows:

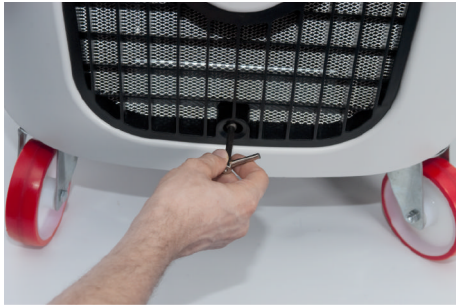

1. Go to the front of the device.
2. Locate the scale locking / unlocking control.
 - **Locking the scale:** *push and turn the locking/unlocking control counter-clockwise using the specific wrench.*
 - **Unlocking the scale:** *push and turn the locking/unlocking control clockwise using the specific wrench.*

9.2 Moving the Device

The equipment must be moved on its own wheels.

The device has been specifically researched and designed to lower the centre of mass; to do so the heavier components have been placed on the bottom, nonetheless it wasn't possible to completely eliminate the risk of overturning.



Follow the safety rules provided in this manual.

Proceed as follows:

1. Lock the refrigerant scale.
2. Unlock the wheels (if necessary) and push the cart using the specific handle located on the back of the equipment.

9.3 Positioning

The device must be placed near the A/C system that must be checked; make sure it is on a flat surface and in an appropriate environment, as specified in the safety regulations within this manual.

Once the device has been positioned, we suggest locking the wheels with the specific mechanical brakes the wheels are equipped with.



Position the equipment so that the main switch can be always reached easily.

9.4 Connection to the Power Mains

The device must be connected to the mains via the specific supply cable provided; respect the applicable voltage, frequency and power values.

The voltage, frequency, and power values that can be applied can be found on the tag located near the main switch.

Proceed as follows:

1. Go to the left hand side of the device.
2. Connect the supply cable to the appropriate connector.
3. Connect the supply cable to the power mains via a socket connected to ground.

9.5 Entering the SD CARD

The **SD CARD** contains the database of the vehicles on which it is possible to carry out air conditioning service and allows you to automatically store each recharging service carried out.



You must insert the SD CARD into the specific slot before use

Proceed as follows:

1. Locate the **SD CARD** slot.
2. Enter the **SD CARD** in the slot with the label facing upwards until you hear a soft click.

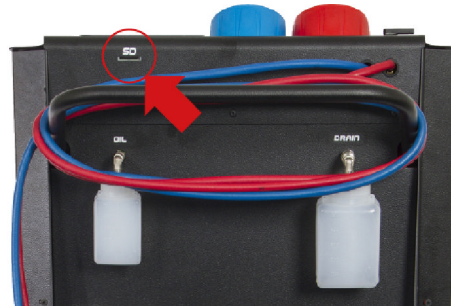

9.6 How to Load the Paper into the Printer

780R stations are equipped with a serial thermal printer.



You must fill the printer with paper before use.

Proceed as follows:

1. Lift the paper compartment opening lever lightly until the corresponding cover locks.
2. Place the paper roll into the specific compartment.
3. Close the compartment pressing lightly on the cover and leaving a slip of paper sticking out.
4. Press  to make sure the paper has been inserted correctly.
5. Repeat the operations indicated above if the paper does not come out.

9.7 How to Fill the Bottles



You must fill the oil and UV tracer bottles before use.



Fill the bottle with the correct type of oil.

9.7.1 Air-tight containers

The bottles provided with the device are empty upon delivery.
In order to fill an air-tight bottle proceed as follows:



1. Remove the bottle by pulling the unlocking handle.
2. Screw the tank cap off.
3. Fill the bottle with the oil/UV tracer.
4. Screw the tank cap on.



5. Reinsert the bottle.

9.7.2 Standard Bottles

To fill a standard bottle proceed as follows:

2. Remove the desired bottle, slightly pulling back on the ferrule on the pneumatic fitting.
2. Screw the tank cap off.
3. Fill the bottle with the oil/UV tracer.
4. Screw the tank cap on.
5. Reinsert the bottle by slightly pulling back the ferrule on the pneumatic fitting.

9.8 How to Fill the Internal Tank

Internal tank in the device is empty upon delivery.



You must carefully read and understand this Operating Manual in order to perform the provided instructions correctly.

Proceed as follows:

1. Turn on the device.
2. Launch the software function for the internal tank filling by selecting the option **ADDITIONAL FUNCTIONS**.



If you are working with the 780R charging station, make sure to select the specific filling function for the gas you intend to refill.

3. Follow the instructions on the display.

9.9 Language Setup

The software within the device can be viewed in different languages.

The languages available are stored within the **SD CARD**.

Italian is the default language.



You must set the software's display language.

This operation must be **carried out when the equipment is started for the first time**.

You may change the language selected at any time by following the instructions provided in this chapter.

The following procedure uses as examples screens displayed by the charging stations that are equipped with a TFT colour display.

Proceed as follows:

1. Turn on the device.

2. Press  until reaching the item **“SETTINGS”**.

3. Press .

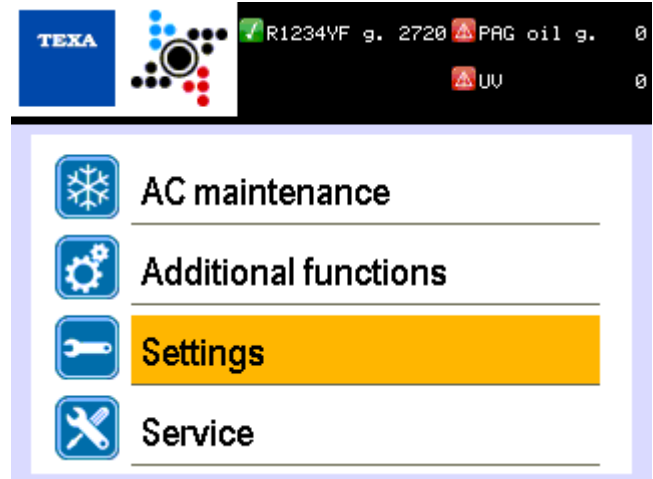

4. Press  until reaching the item **“LANGUAGE”**.

5. Press .

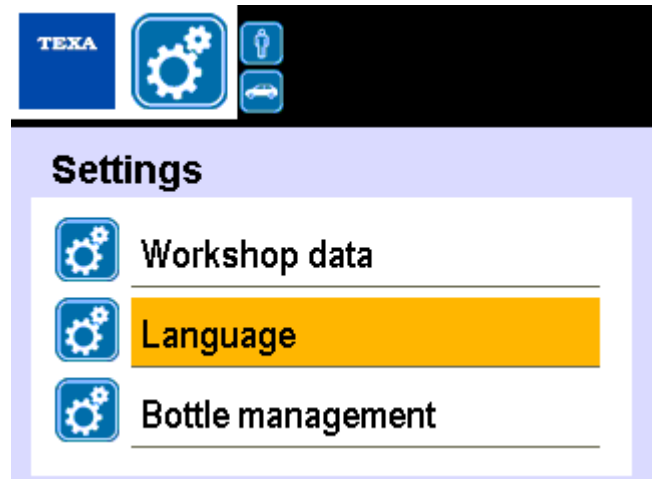

6. Press  until reaching the item that corresponds to the desired language.

7. Press .

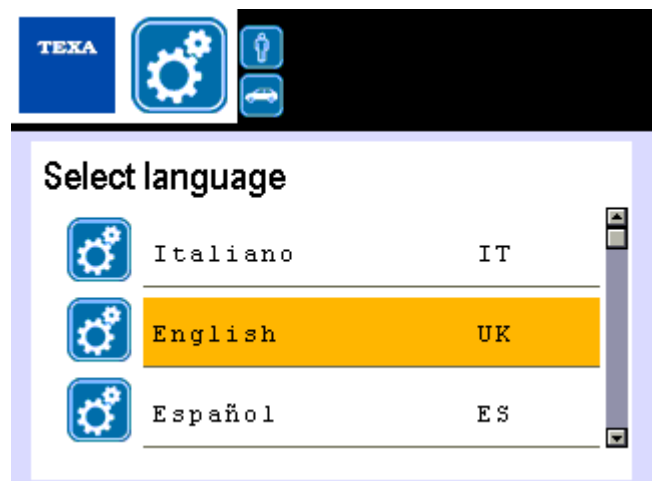

8. The language is set.

The procedure for setting the language is the same as the one described for the following charging stations:



- 705R
- 705R OFF ROAD
- 710R
- 710L
- 712R
- 720R

10 START-UP

This chapter describes the operations required in order to start up the device.

10.1 Switching on

To start up the device, set the main switch in the I (ON) position.

10.2 Activation

The device includes a demo mode (**Demo**).

The device can be used in **Demo** mode for a **maximum cycle of 15 power on-power offs**.



The equipment locks automatically at the end of the cycle and can no longer be used.



In order to unlock the equipment you must enter a specific countercode.

Proceed as follows:

1. Contact your dealer.
2. Give the retailer the code.
3. Enter the counter-code into the software.

11 User Instructions

This chapter provides various general instructions on how to use the device.

11.1 How to Connect to the Vehicle Air Conditioning System

In order to carry out A/C system recharging operations you are required to connect the device to the vehicle.

Proceed as follows:

1. Place the device near the A/C system you wish to check.
2. Connect the service tubes to the vehicle A/C system.

11.2 Visual Warnings

The control panel/display on the device has a series of LEDs that provide information on the status of the device and on the phase in progress at a specific time.

Name Symbol	Colour	Indicates	Blink Code
GAS	Orange	R134a is being used	ON: refrigerant is being used. OFF: device is turned off.
	Green	Using the refrigerant R1234yf	
	Blue	Bluetooth activity	Flashing: Bluetooth communication in progress. Off: no Bluetooth communication.
REC	Green	Recycling Phase	ON: phase selected or complete. Flashing: phase being selected or carried out. OFF: phase not carried out.
VAC	Blue	Vacuum Phase	
INJ	Orange	Injection Phase	
REF	Red	Recharging Phase	

11.3 Audible Warnings





The control panel/display on the device has an electronic buzzer.

The operator is informed of any errors or warnings regarding the service, not only via messages that appear on the display, but also via a "beep".

11.4 How to Use the Software

The software within the **KONFORT 700R Series** allows you to select the vehicle on which you wish to work by selecting it among those within the database. It also allows you to launch all the functions required in order to recharge and check the vehicle A/C system.

The keypad on the top panel of the device acts as an operator-machine interface and allows you to select and launch the functions available, enter specific data for the operation that needs to be carried out and, in general, allows you to complete all the operations the software permits.

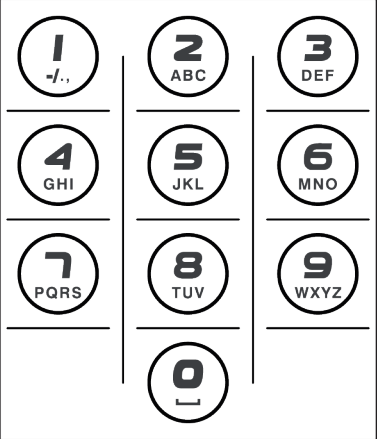
Key	Name	Function
	ENTER	Allows you to confirm the selection made.
	DELETE	Allows you to delete data that has been entered.
	STOP/BACK/CANCEL	Allows you to instantly stop the phase in progress or go back to the previous menu.
	INFO	Allows you to view specific additional information regarding the menu selected.
	UP/DOWN ARROW	Allows you to scroll the options within a menu.
	NUMERIC KEYPAD	These keys allow you to enter the alphanumeric values required to carry out the recharging operations and data related to the client and the company.



The software provides on-screen instructions to help the operator to carry out the various operations and warns the operator if any error occurs during the individual phases.

For further information consult the software's Operating Manual.

11.5 Printer

The thermal printer is available on the **780R** recharging stations.

The keys on the printer have the following functions:

Key	Name	Function
	PAPER ADVANCE	Allows the paper to come out.
	ON/OFF	Allows the printer to go into on-line/off-line mode.

The printer is equipped with a green LED that indicates its status. The states may be as follows:

- **Fixed on:** *printer on-line*
- **Flashing:** *the printer is off-line or there is no paper in the printer.*
- **OFF:** *printer off-line*

The printer is automatically on-line upon equipment startup.

Press  if the status LED indicates that the printer is off-line.

Using the printer the operator may print a report containing the following information:

- *company data*
- *vehicle data*
- *client data*
- *operations carried out*

The data relative to the company, vehicle and the client can be entered using the numeric keypad.

For further information consult the software's Operating Manual.

12 STOP

This chapter describes the operations required in order to stop the equipment.

12.1 Normal Stop

To stop the equipment, set the main switch to the **O** (OFF) position.



Do not disconnect the device from the power mains by unplugging the power supply cable either from the device or from the socket.

12.2 Stopping the Equipment for Long Periods

Should you intend to stop the equipment for a long period of time, follow the instructions below.

Proceed as follows:

1. Disconnect the equipment from the power mains.
2. Place the cover provided over the device.
3. Put the device in a safe place, not exposed to outside weather conditions.

13 UPDATING

This chapter describes the operations needed to update the equipment's operating system.

The update takes place through the **SDCARD**.



You must have a PC with a USB port and an active Internet connection available.

Proceed as follows:

1. Turn off the device.
2. Locate the **SD CARD** slot.
3. Gently press on the **SD CARD** to unlock it.
4. Remove the **SD CARD**.
5. Enter the **SD CARD** into the **SD CARD READER**.
6. Connect the **SD CARD READER** to a PC.

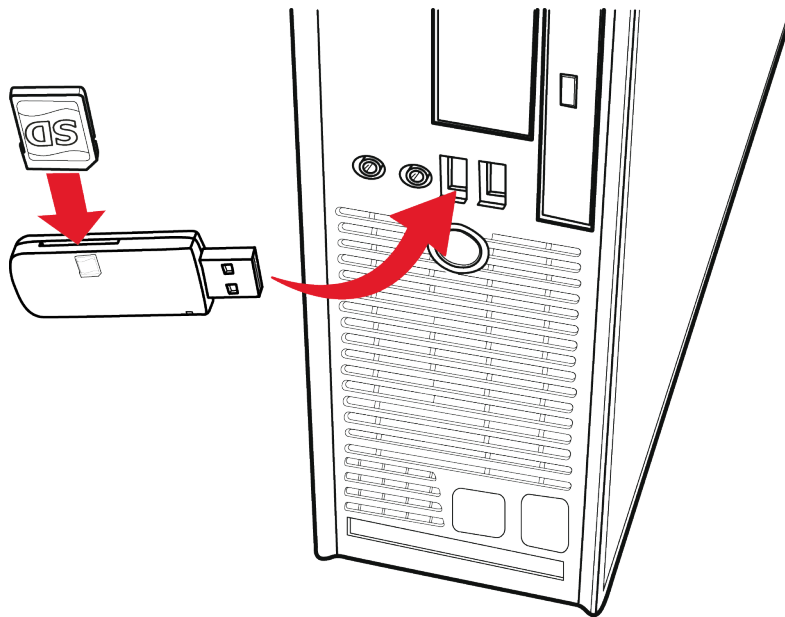

7. Copy the update into the **SD CARD**.
8. Remove the **SD CARD** from the **SD CARD READER**.
9. Enter the **SD CARD** into the appropriate slot on the device.
10. Turn on the device.

The update starts automatically.



During the update, the display will remain off and the green LED on the top will flash intermittently.

11. Wait for the update to complete.

12. Once the update is complete, the software restarts automatically.

14 MAINTENANCE

This chapter describes the maintenance operations required for the device.



Carefully follow the instructions provided in this manual.



Only use original spare parts or approved by TEXA.

For more information contact the post-sales assistance service.

14.1 Ordinary Maintenance

Scheduled maintenance is made up of a series of operations that must be carried out periodically.

Specific messages will appear on your display each time a maintenance operation has expired and needs to be carried out.

Maintenance operation	Frequency
Dryer Filter Replacement	When prompted by the device.
Mechanical Filter Replacement	Along with the dehydrator filter replacement.
Vacuum pump oil replacement	When prompted by the device.
Printer paper replacement*	each time the paper runs out.

(*) *Only for 780R charging stations or for charging stations on which the optional printer kit has been installed.*



The maintenance operations that require you to open the service door / bulkheads and to remove parts of the equipment must be carried out with the equipment switched off.

KONFORT 720R / 760R / 760R BUS / 780R BI-GAS

Following is the procedure for opening the service door correctly on the models:

- **720R**
- **760R**
- **760R BUS**
- **780R BI-GAS**

Proceed as follows:



1. Go behind the device.
2. Locate the service flap.
3. Lift the opening lever.
4. Turn the lever clockwise.
5. Open the service flap.

KONFORT 710R / 710L

Following is the procedure for opening the service bulkheads correctly on the models:

- **710R**
- **710L**
- **712R**

The procedure is the same for both the service bulkhead that allows you to access the filter and for the one that allows you to access the vacuum pump.

Proceed as follows:

1. Go behind the device.
2. Locate the service bulkhead to remove.
3. Loosen the four screws that block the bulkhead using an hexagonal wrench n° 3.
4. Remove the bulkhead.

KONFORT 707R / 705R / 705 OFF ROAD

Following is the procedure for opening the service bulkheads correctly on the models:

- **705R**
- **705R OFF ROAD**
- **707R**

In order to carry out the charging station maintenance operations described above, you must remove the front shield.

Proceed as follows:

1. Go behind the device.
2. Using a n° 3 hexagonal wrench remove the four screws that fasten the front cover to the body of the machine.
3. Stand in front of the recharging station.
4. Using a n° 3 hexagonal wrench loosen the two screws that fasten the front cover to the top cover.
5. Lift the top cover slightly.
6. Remove the front cover.

14.1.1 Dryer Filter Replacement

The filter must be replaced **when you are prompted to do so by the device.**



Carefully follow the instructions provided below in order to avoid the refrigerant from getting into the atmosphere.



There could be accidental refrigerant leaks while replacing the filter.



Wear appropriate protective glasses and gloves while replacing the filter.



You must carefully read and understand this Operating Manual in order to perform the provided instructions correctly.

Before replacing the filter you must reset the **"filter counter"** using the appropriate software function.

Proceed as follows:

1. *Switch on the equipment.*
2. **Select ADDITIONAL FUNCTIONS -> RESET COUNTER -> FILTER REPLACEMENT.**
3. *Follow the instructions on the display.*



Do not open the equipment's service door until it is specifically indicated on the display.

After resetting the counter you can replace the filter.

KONFORT 710R / 710L / 712R / 720R / 760R / 760R BUS / 780R BI-GAS

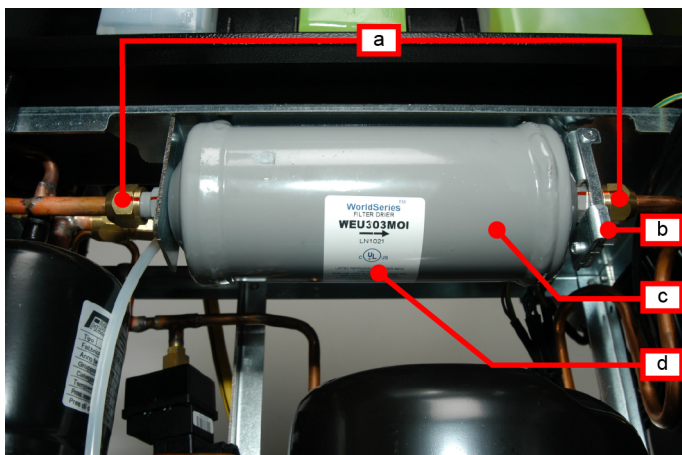

- a) Screw nuts for the filter
- b) Blocking clip
- c) Filter
- d) Arrow indicating the direction of the flow

KONFORT 707R / 705R / 705 OFF ROAD

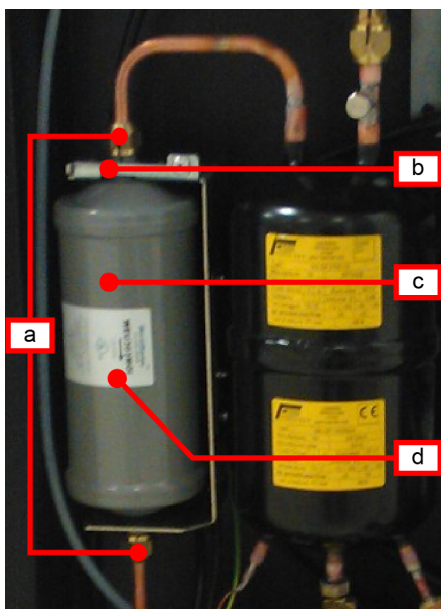

- a) Screw nuts for the filter
- b) Blocking clip
- c) Filter
- d) Arrow indicating the direction of the flow

Proceed as follows:

1. Access the components inside the recharging station:

- **720R / 760R / 760R BUS / 780R BI-GAS:** open the service lid.
- **710R / 710L / 712R:** remove the service cover.
- **707R / 705R / 705 OFF ROAD:** remove the front shield.

2. Open the filter's blocking clip.

3. Unscrew the fixing nuts of the dryer filter using appropriate hexagonal wrenches n° 16 and n° 19.

4. Remove the filter by slipping it from the right side.

5. Check that the sealing O-rings are in good condition and replace them if necessary.

6. Install the new filter screwing the fixing nuts with a tightening torque of approximately 17 N m.



The arrow that indicates the flow in the filter must point towards the right.

7. Close the filter's blocking clip.
8. Close the recharging station.
9. Complete the operation following the instructions on the display.

14.1.2 Mechanical Filter Replacement

The mechanical filter must be replaced at the same time the dehydrator filter is replaced.



Follow the same safety precautions indicated in the Dryer Filter Replacement chapter.

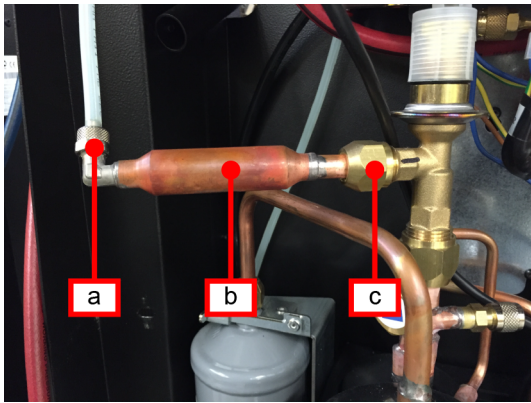

In models:

- 705R
- 707R

the mechanical filter is located **over** the dryer filter.

- a) *Rilsan pipe connection - mechanical filter.*
- b) *Mechanical filter.*
- c) *Constant expansion valve connection - mechanical filter*

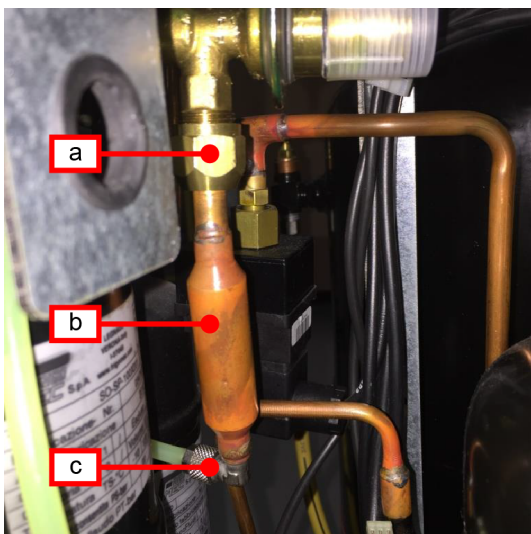

In models:

- 710R
- 710L
- 712R
- 720R
- 760R
- 760R BUS
- 780R BI-GAS

the mechanical filter is located **behind** the dehydrator filter.

- a) *Constant expansion valve connection - mechanical filter*
- b) *Mechanical filter.*
- c) *Rilsan pipe connection - mechanical filter.*

Proceed as follows:

1. *Open the service flap.*
2. *Remove the dehydrator filter (see **Dehydrator Filter Replacement** chapter).*
3. *Locate the mechanical filter.*
4. *Unscrew the Rilsan pipe connection - mechanical filter, using a proper spanner wrench.*
5. *Unscrew the constant expansion valve connection - mechanical filter, using a spanner wrench n° 19.*
6. *Remove the filter.*
7. *Mount an O-ring on the new filter on the side of the constant expansion valve connection.*
8. *Remount the filter using the specific tools and tightening with a torque of approximately 17 Nm.*

14.1.3 How to Replace the Vacuum Pump Oil

The oil in the vacuum pump must be replaced **when you are prompted to do so by the device.**



You must carefully read and understand this Operating Manual in order to perform the provided instructions correctly.

KONFORT 710R / 710L / 712R/ 720R / 760R / 760R BUS / 780R BI-GAS

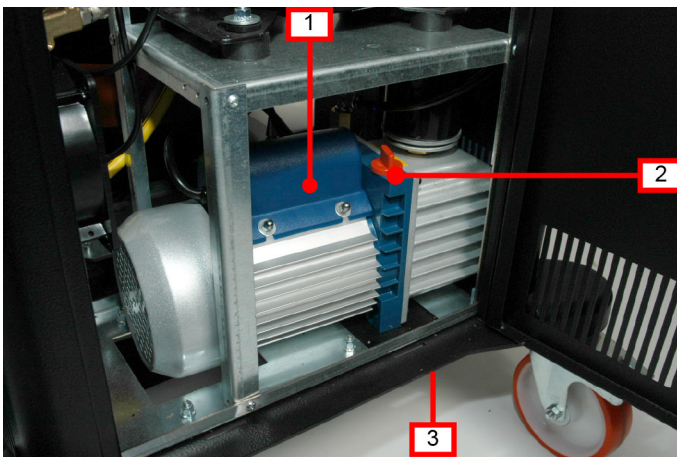

1. *Vacuum pump*
2. *Filler cap*
3. *Oil drain cap**
4. *Pump oil level inspection*

KONFORT 707R / 705R / 705R OFF ROAD

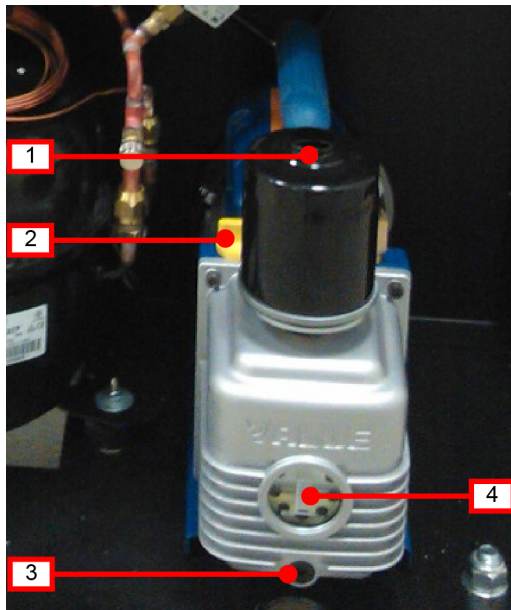

1. Vacuum pump
2. Filler cap
3. Oil drain cap*
4. Pump oil level inspection

(*) In the following charging stations the oil drain cap is located under the equipment, close to the pump oil level check:

- **710R**
- **710L**
- **712R**
- **720R**
- **760R**
- **760R BUS**
- **780R BI-GAS**

Proceed as follows:

1. Disconnect the device from the power mains.
2. Unscrew the oil drain cap.
3. Wait for all the oil to drain from the pump.

! Collect the recovered oil and dispose of it according to the regulations in force.

4. Screw the oil drain cap on.
5. Unscrew the oil filler cap.
6. Fill with new oil.

! The correct pump oil level is approximately half of the level warning light and the total amount to refill is approximately 370 ml.

7. Screw the oil filler cap on.
8. Reset the **Pump Time Counter Reset**.

14.1.4 Replacing the Paper in the Printer

Follow the instructions provided in the chapter **Replacing the Paper in the Printer**.

14.2 Periodical Checks

In order to guarantee a correct operation of the device we recommend you check the parts that are the most subject to wear on a regular basis.

Parts subject to wear	Check
Service hoses	Make sure there are no cuts, scratches or bulges.
Quick fittings	Make sure there are no signs of wear and that the hoses do not harden during use. Make sure the service hoses are connected properly. Make sure there are no cuts or scratches on the O-rings.
Oil and UV bottles	Make sure they are clear and not damaged.
Wheels	Make sure the brakes are working properly.
Power supply cable	Make sure there are no cuts, scratches or burns.

14.3 Periodical Safety Checks

In order to guarantee the correct operation of the device, carry out periodical checks on the safety devices.

The safety valve and safety pressure switch must be visually checked to verify that they are not damaged in order to guarantee that they are working properly.



A periodic inspection of the operation of the safety devices (Safety Pressure Switch and Safety Valve) and of the integrity of the refrigerant liquid receiver must be carried out at intervals defined by the national regulations in force in the country in which the equipment is being used.

15 DISPOSAL

Below you will find information on how to properly dispose of the device.

15.1 How to Dispose of the Device

In order to dispose of the device proceed as follows:

1. Ask assistance personnel to collect all the refrigerant within the internal circuit, making sure the internal storage tank is emptied as well.
2. Take the device to a waste disposal centre.

For more information regarding the disposal consult the pamplet provided with the device.

15.2 How to Dispose of the Recycled Materials

The refrigerants that cannot be reused must be taken to the supplier of the refrigerant for it to be disposed of.



The oils removed from the systems must be taken to used oil collection centres.

16 DATA PLATE

Every single device is accompanied by an identification data plate just as the one in the example provided below:



Via 1 Maggio, 9
31050 Monastier di Treviso (TV)
ITALY

XXXXXXXXXX

Modello Type	xxxxx	Alimentazione Power supp.	230 V
Fluido / Gruppo Fluid / Group	R134a / 2 R1234yf / 1	Potenza Assorb. Power Absorb.	770 W
Carica massima fluido Max refrigerant charge	20 kg	Anno / Year	2017
PS 20 bar	TS 5/40 °C	Tarat. disp. secur. Safety dev. calib.	20 bar

Contiene gas fluorati ad effetto serra disciplinati dal Protocollo di Kyoto
 Contains fluorinated greenhouse gases covered by Kyoto Protocol

Where:

- **PS:** *maximum operating pressure;*
- **TS:** *operating temperature.*

17 KONFORT 720R / 760R / 760R BUS / 780R BI-GAS TECHNICAL FEATURES

Builder	TEXA S.p.A.	TEXA S.p.A.	TEXA S.p.A.	TEXA S.p.A.
Model	720R	760R	760R BUS	780R
Fluid / Group	R134a / 2 R12324yf / 1	R134a / 2 R12324yf / 1	R134a / 2 R12324yf / 1	R134a / 2 R12324yf / 1
Electronic refrigerant scale (Precision) [g]	± 10	± 10	± 10	± 10
Electronic oil and UV tracer scales (Resolution) [g]	--	1	1	1
Pressure transducer	KI. 1.0	KI. 1.0	KI. 1.0	KI. 1.0
High pressure gauge [mm]	Ø 100	Ø 100	Ø 100	Ø 100
Low pressure gauge [mm]	Ø 80	Ø 80	Ø 80	Ø 80
Tank capacity [kg]	12	20	30	2 x 12
Service pipes' length [m]	3	3	3	3
Filter assembly	1 combined filter + mechanical filter	1 combined filter + mechanical filter	1 combined filter + mechanical filter	1 combined filter + mechanical filter
Compressor	12 cc airtight	12 cc airtight	21 cc airtight	12 cc airtight
Vacuum pump	100 l/m, double stage, final pressure 0,03 mBar	100 l/m, double stage, final pressure 0,03 mBar	146 l/m, double stage, final pressure 0,03 mBar	100 l/m, double stage, final pressure 0,03 mBar

Ambient temperature sensor (Resolution) [°C]	1	1	1	1
Tilt sensor (Resolution on the 3 axes)	--	1°	1st	1st
Display	LED 240x128	TFT 320x640	TFT 320x640	TFT 320x640
SD card memory capacity [GB]	8	8	8	8
Refrigerant purity [kg]	150 (SAE J2099)	150 (SAE J2099)	150 (SAE J2099)	150 (SAE J2099)
Recovery efficiency	> 95 % (SAE J2788 / SAE J2843)	> 95 % (SAE J2788 / SAE J2843)	> 95 % (SAE J2788 / SAE J2843)	> 95 % (SAE J2788 / SAE J2843)
Maximum operating pressure (PS) [bar]	20	20	20	20
Safety device calibration [bar]	20	20	20	20
Operation temperature (TS) [°C]	5 ÷ 40	5 ÷ 40	5 ÷ 40	5 ÷ 40
Storing temperature [°C]	- 25 ÷ 60	- 25 ÷ 60	- 25 ÷ 60	- 25 ÷ 60
Dimensions [mm]	H: 1195 L: 598 D: 706	H: 1195 L: 598 D: 706	H: 1195 L: 598 D: 706	H: 1195 L: 598 D: 706
Weight [kg]	101	110	123	121

Power supply voltage [V] (Only for Japan)	230	230 (100)	230	230 (100)
Frequency (Hz) : (Only for Japan)	50	50 (50 / 60)	50	50 (50 / 60)
Power [W]	770	770	900	770

18 KONFORT 710R / 710L / 712R TECHNICAL FEATURES

Builder	TEXA S.p.A.	TEXA S.p.A.	TEXA S.p.A.
Model	710R	710L	712L
Fluid / Group	R134a / 2	R134a / 2	R1234yf / 1 R134a / 2
Electronic refrigerant scale (Precision) [g]	± 10	± 10	± 10
Electronic oil and UV tracer scales (Resolution) [g]	--	--	1 (only oil drain)
Pressure transducer	KI. 1.0	KI. 1.0	KI. 1.0
High pressure gauge [mm]	Ø 80	Ø 80	Ø 80
Low pressure gauge [mm]	Ø 80	Ø 80	Ø 80
Tank capacity [kg]	10	20	20
Service pipes' length [m]	3	3	3
Filter assembly	1 combined filter + mechanical filter	1 combined filter + mechanical filter	1 combined filter + mechanical filter
Compressor	12 cc airtight	12 cc airtight	12 cc airtight
Vacuum pump	100 l/m, double stage, final pressure 0,03 mbar	100 l/m, double stage, final pressure 0,03 mbar	100 l/m, double stage, final pressure 0,03 mbar
Ambient temperature sensor (Resolution) [°C]	1	1	1
Tilt sensor (Resolution on the 3 axes)	--	--	--
Display	LED 240X128	LED 240X128	LED 240X128

SD card memory capacity [GB]	8	8	8
Refrigerant purity [kg]	150 (SAE J2099)	150 (SAE J2099)	150 (SAE J2099)
Recovery efficiency	> 95 % (SAE J2788)	> 95 % (SAE J2788)	> 95 % (SAE J2788)
Maximum operating pressure (PS) [bar]	20	20	20
Safety device calibration [bar]	20	20	20
Operation temperature (TS) [°C]	5 ÷ 40	5 ÷ 40	5 ÷ 40
Storing temperature [°C]	- 25 ÷ 60	- 25 ÷ 60	- 25 ÷ 60
Dimensions [mm]	H: 1078 L: 598 D: 706	H: 1078 L: 598 D: 706	H: 1078 L: 598 D: 706
Weight [kg]	90	90	90
Power supply voltage [V]	230	230	230
Frequency (Hz) :	50	50	50
Power [W]	770	770	770

19 KONFORT 705R / 705R OFF ROAD / 707R / 710R / 710L

TECHNICAL FEATURES

Builder	TEXA S.p.A.	TEXA S.p.A.	TEXA S.p.A.
Model	705R	705R OFF ROAD	707R
Fluid / Group	R134a / 2	R134a / 2	R1234yf / 1
Electronic refrigerant scale (Precision) [g]	± 10	± 10	± 10
Electronic oil and UV tracer scales (Resolution) [g]	--	--	--
Pressure transducer	KI. 1.0	KI. 1.0	KI. 1.0
High pressure gauge [mm]	Ø 80	Ø 80	Ø 80
Low pressure gauge [mm]	Ø 80	Ø 80	Ø 80
Tank capacity [kg]	10	10	10
Service pipes' length [m]	3	3	3
Filter assembly	1 combined filter + mechanical filter	1 combined filter + mechanical filter	1 combined filter + mechanical filter
Compressor	12 cc airtight	12 cc airtight	12 cc airtight
Vacuum pump	100 l/m, single stage, final pressure 0,05 mbar	100 l/m, single stage, final pressure 0,05 mbar	100 l/m, single stage, final pressure 0,05 mbar
Ambient temperature sensor (Resolution) [°C]	1	1	1
Tilt sensor (Resolution on the 3 axes)	--	--	--
Display	LED 240x128	LED 240x128	LED 240x128

SD card memory capacity [GB]	8	8	8
Refrigerant purity [kg]	150 (SAE J2099)	150 (SAE J2099)	150 (SAE J2099)
Recovery efficiency	> 95 % (SAE J2788)	> 95 % (SAE J2788)	> 95 % (SAE J2843)
Maximum operating pressure (PS) [bar]	20	20	20
Safety device calibration [bar]	20	20	20
Operation temperature (TS) [°C]	5 ÷ 40	5 ÷ 40	5 ÷ 40
Storing temperature [°C]	- 25 ÷ 60	- 25 ÷ 60	- 25 ÷ 60
Dimensions [mm]	H: 1078 L: 598 D: 706	H: 1078 L: 598 D: 706	H: 1078 L: 598 D: 706
Weight [kg]	75	75	75
Power supply voltage [V]	230	230	230
Frequency (Hz) :	50	50	50
Power [W]	770	770	770

20 FLOW DIAGRAMS

KONFORT 705R / 705R OFF ROAD

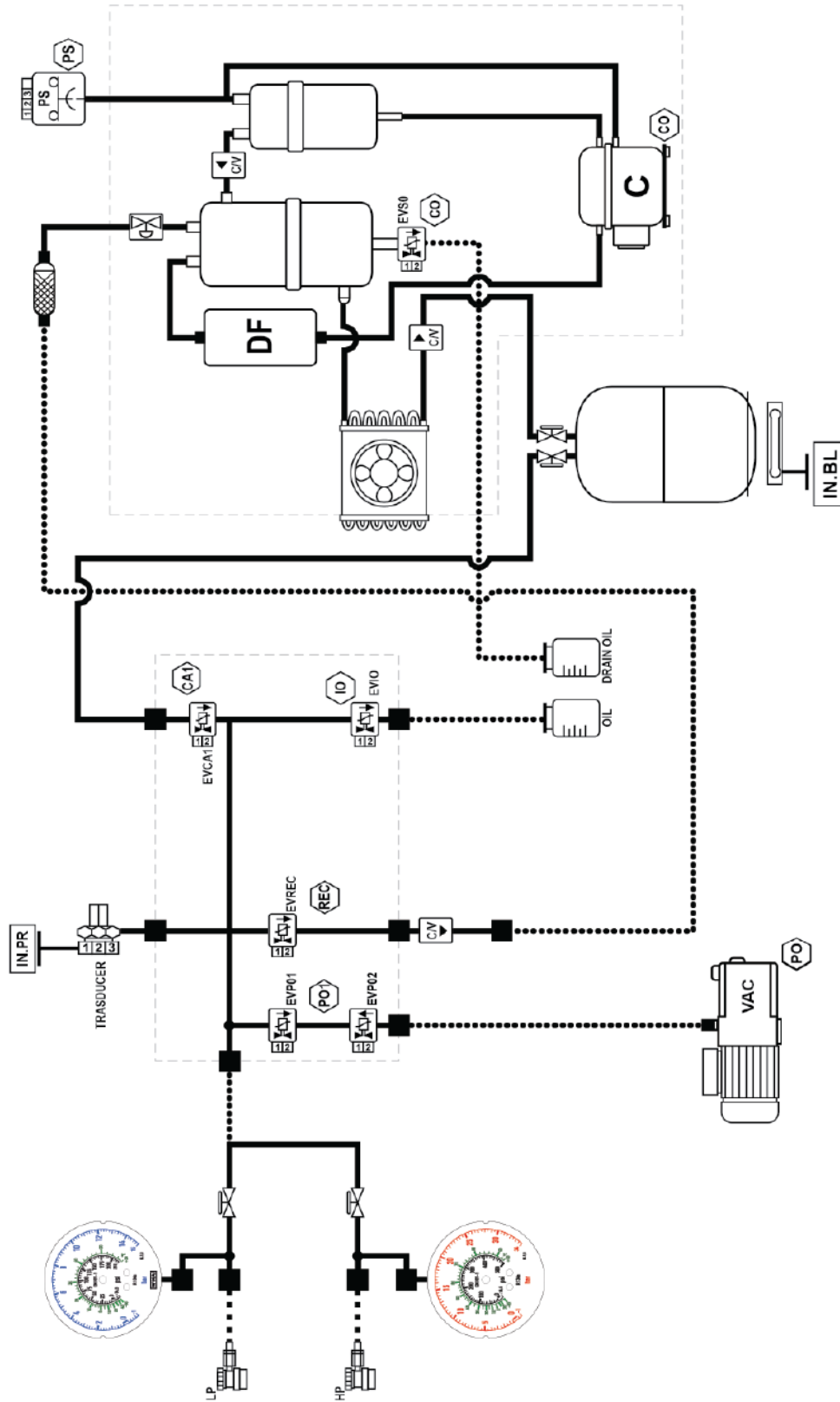

KONFORT 707R

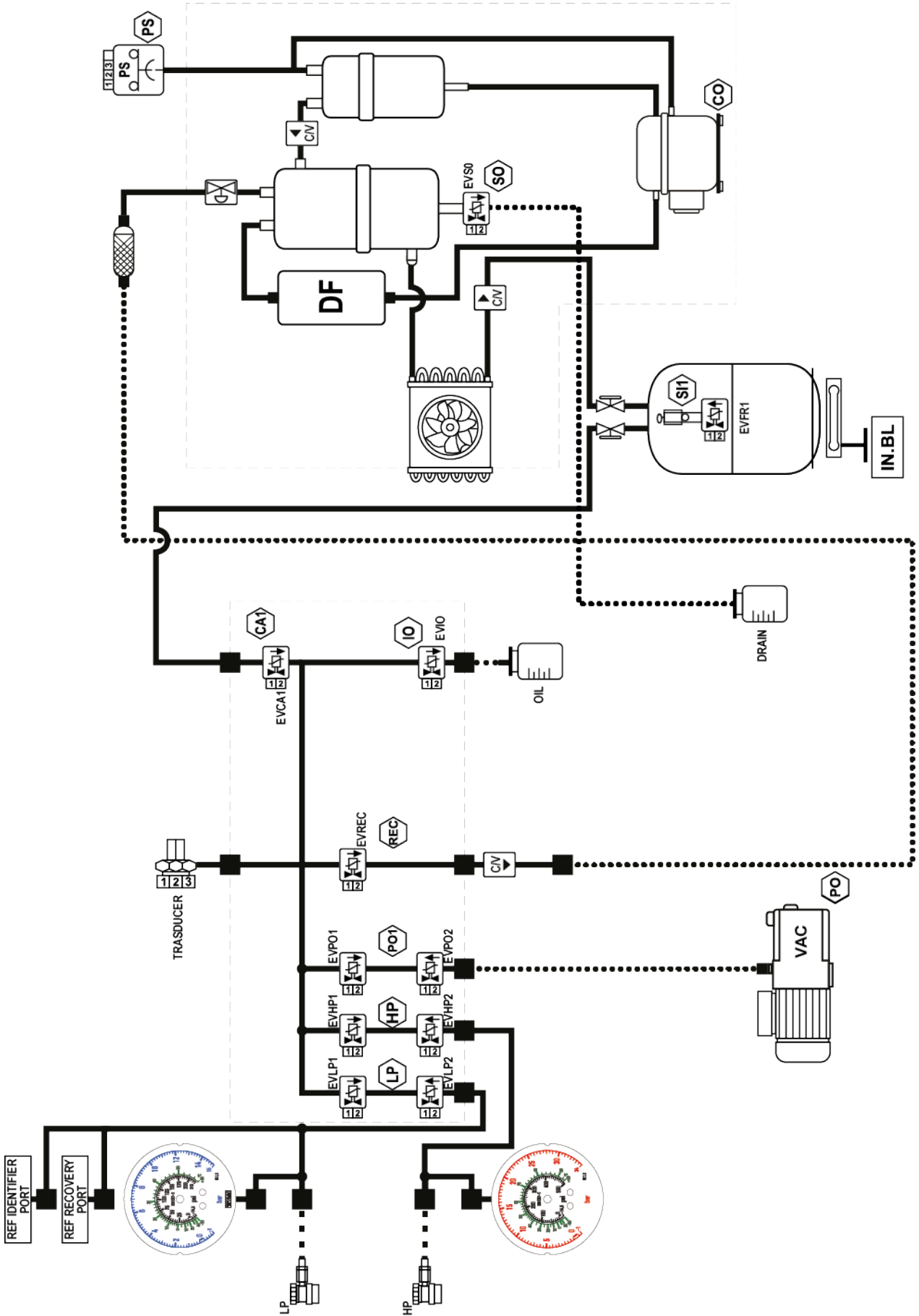

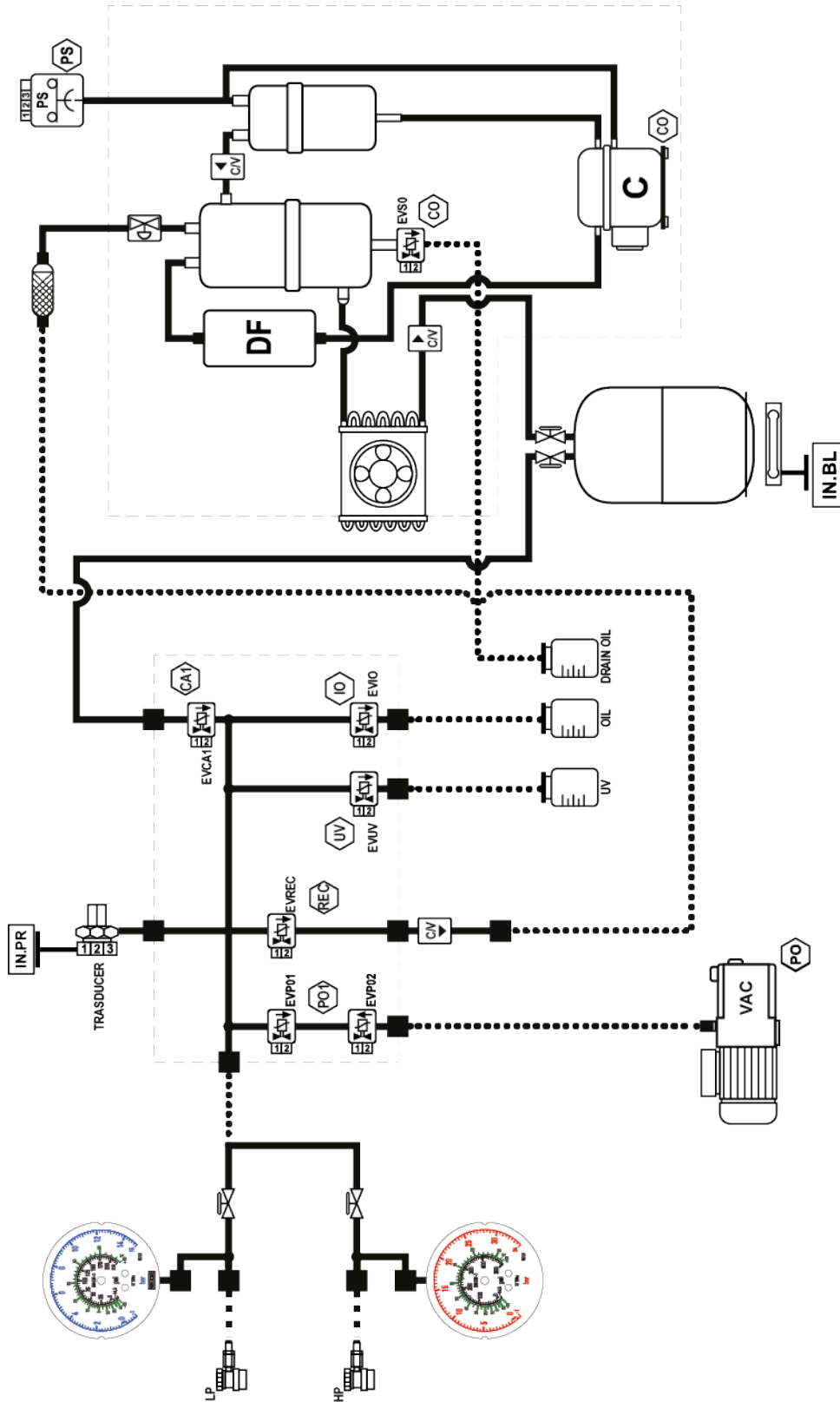

KONFORT 712R

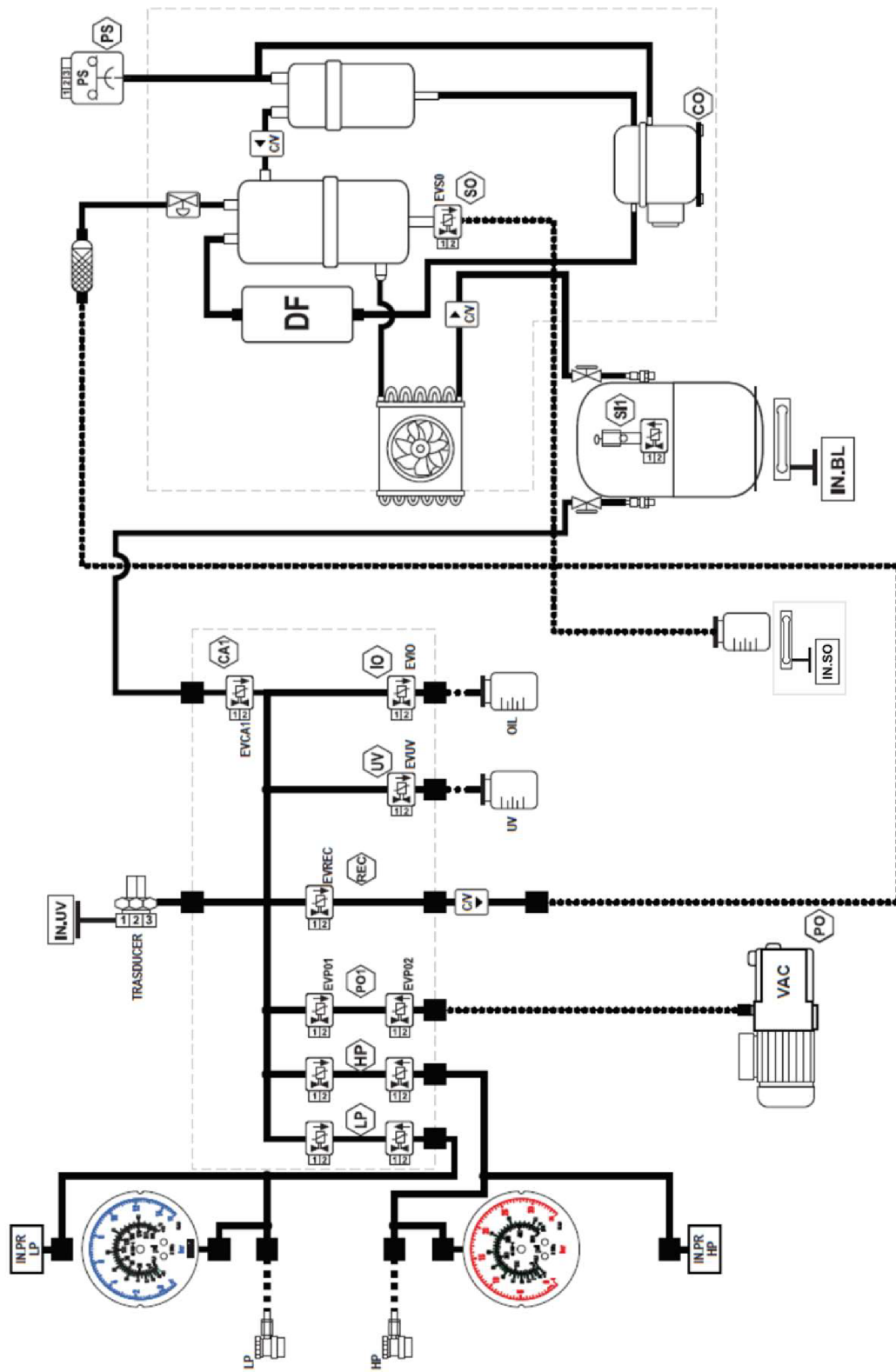

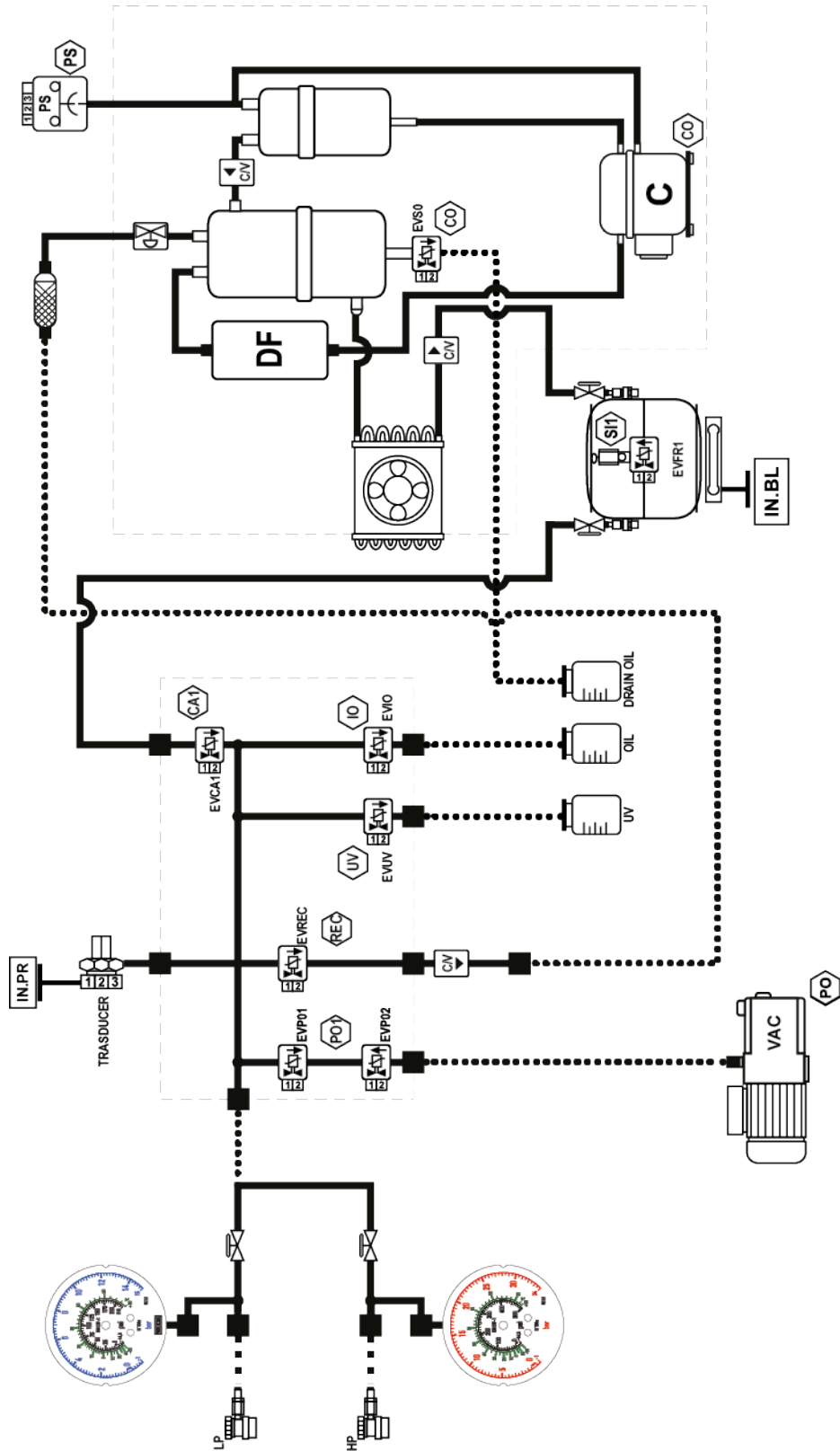

KONFORT 760R / 760 BUS

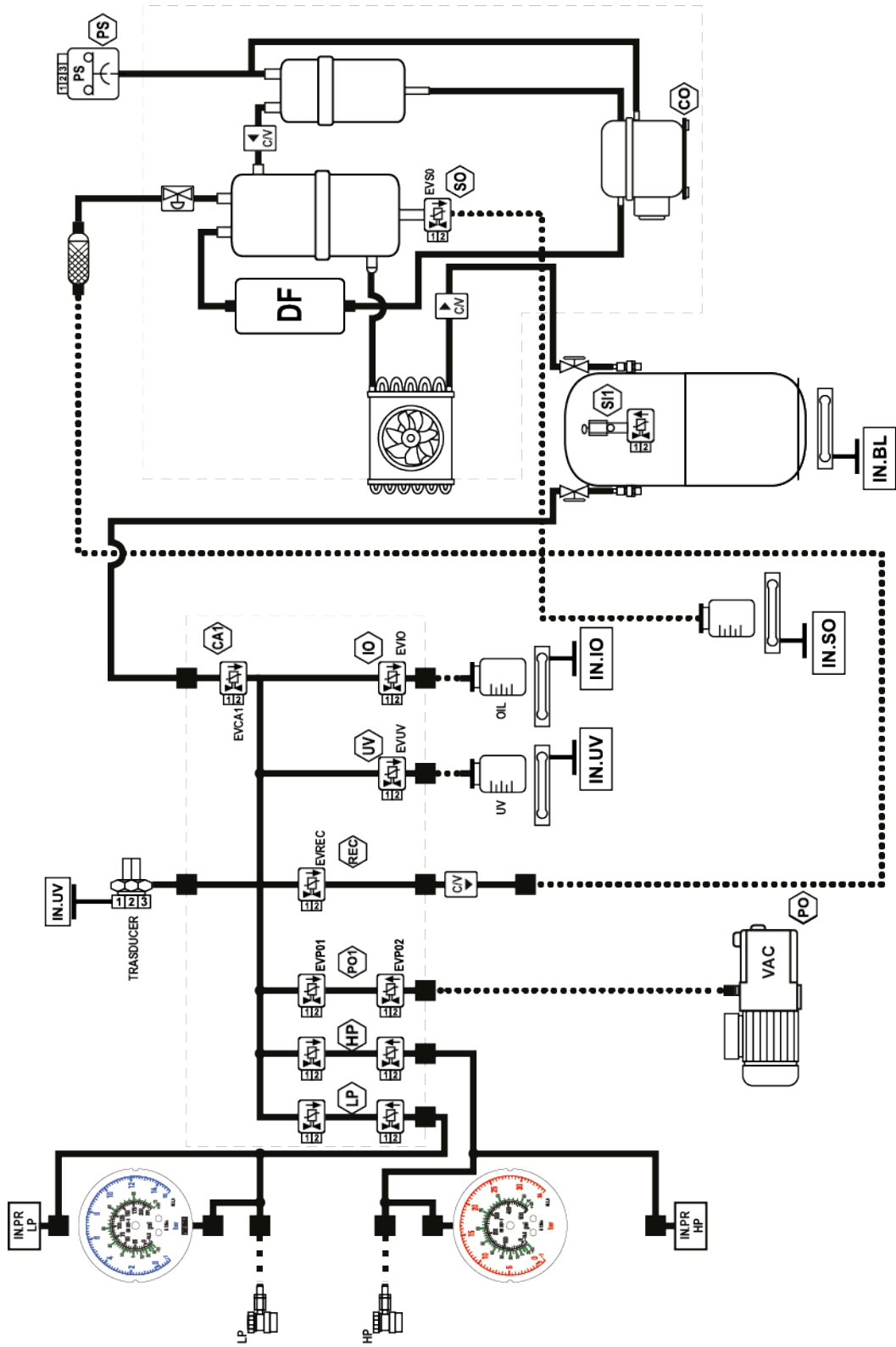

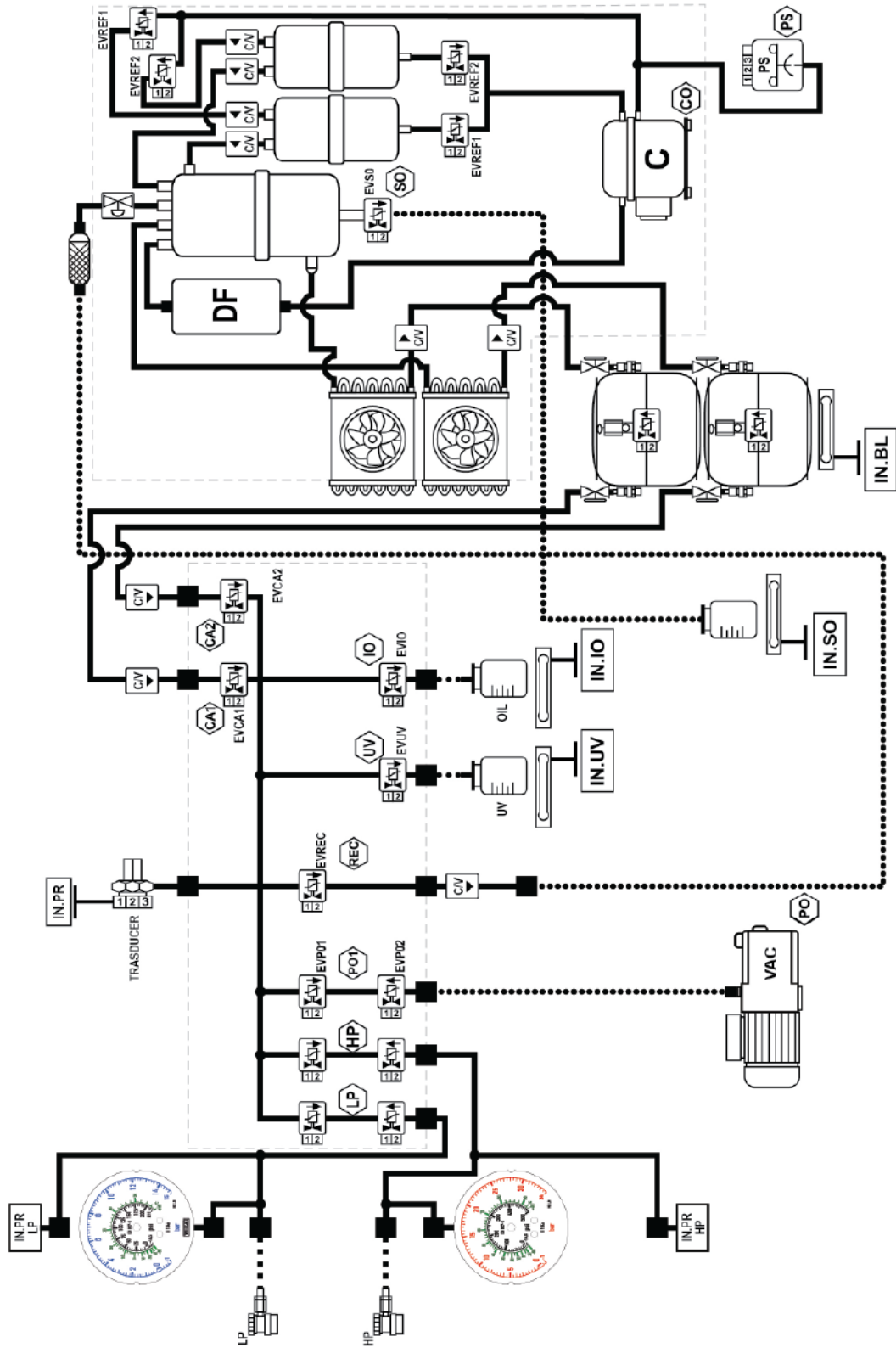

21 LEGAL NOTICES

TEXA S.p.A.

Via 1 Maggio, 9 - 31050 Monastier di Treviso - ITALY

Tax Code - Company Register of Treviso ID No. - VAT No.: 02413550266

Single-shareholder company subject to the direction and coordination activities of Opera Holding S.r.l.

Paid-up share capital 1,000,000 €- R.E.A. (Economic Administrative Index) No. 208102

Legal Representative Bruno Vianello

Phone +39 0422.791.311

Fax +39 0422.791.300

www.texa.com

For information regarding the legal notices, please refer to the **International Warranty Booklet** provided with the product.